

MWS65

RELIABILITY DATA

DWG No. FA001-57-01		
APPD	CHK	DWG
<i>Frank. cllrzn</i>	<i>Amos Chan</i>	<i>Tony Chiu</i>
<i>26 Jul/2011</i>	<i>26 Jul '11</i>	<i>26 Jul '11</i>

INDEX

	PAGE
1 . Calculated values of MTBF	R-1
2 . Component derating	R-2~4
3 . Main components temperature rise ΔT list	R-5~8
4 . Electrolytic capacitor lifetime	R-9~20
5 . Abnormal test	R-21
6 . Vibration test	R-22
7 . Noise simulate test	R-23
8 . Thermal shock test	R-24

※ Test results are typical data. Nevertheless the following results are considered to be actual capability data because all units have nearly the same characteristics.

1 . Calculated values of MTBF

MODEL : MWS65

(1) Calculating method

Calculated based on part count reliability projection of MIL-STD-217F. Individual failure rates λ_G is given to each part and MTBF is calculated by the count of each part.

<Formula>

$$MTBF = \frac{1}{\lambda_{equip}} = \frac{1}{\sum_{i=1}^n n_i (\lambda_G \pi_Q)_i} \times 10^6 \quad (\text{hours})$$

MTBF = 1E+06 / Total equipment failure rate

λ_{equip} : Total equipment failure rate (failure / 10⁶hours)

λ_G : Generic failure rate for the ith generic part (failure / 10⁶hours)

n_i : Quantity of ith generic part

n : Number of different generic part categories

π_Q : Generic quality factor for the ith generic part

(2) MTBF values

G_F : (Ground, Fixed)

T_a : 50°C

MIL-STD-217F

MWS65-5 MTBF ≐ 469,603 (hours)

2 . Components derating

MODEL : MWS65

(1) Calculating method

(a) Measuring method

• Mounting method : Standard mounting : A	• Ambient temperature : 50°C
• Input voltage : 115, 230VAC	• Output voltage & current : 5V, 11A(100%) : 24V, 2.8A(100%)

(b) Semiconductors

Compared with maximum junction temperature and actual one which is calculated based on case temperature, power dissipation and thermal impedance.

(c) IC, Resistors, Capacitors, etc.

Ambient temperature, operating condition, power dissipation and so on are within derating criteria.

(d) Calculating method of thermal impedance

$$\theta_{j-c} = \frac{T_j(\max) - T_c}{P_c(\max)} \quad \theta_{j-l} = \frac{T_j(\max) - T_l}{P_c(\max)}$$

T_c : Case temperature at start point of derating ; 25°C in General

T_l : Lead temperature at start point of derating ; 25°C in General

$P_{ch}(\max)$: Maximum channel dissipation

$T_j(\max)$: Maximum junction (channel) temperature
($T_{ch}(\max)$)

θ_{j-c} : Thermal impedance between junction (channel) and case
(θ_{ch-c})

θ_{j-l} : Thermal impedance between junction (channel) and lead
(θ_{ch-l})

(2-1) Component derating list

.MWS65-5

Location No.	Vin = 115VAC	Load = 100%	Ta = 50°C
Q1 TK8A65D(Q) TOSHIBA	Tch (max) = 150 °C Pch = 2.33 W Tch = Tc + ((θch-c) × Pch) = 116.3 °C D.F. = 77.5 %	θch-c = 2.78 °C/W ΔTc = 59.8 °C	Pch (max) = 45 W Tc = 109.8 °C
D1 RS405M RECTRON	Tj (max) = 150 °C Pd = 2.16 W Tj = Tc + ((θj-c) × Pd) = 114.1 °C D.F. = 76.0 %	θj-c = 4.2 °C/W ΔTc = 55.0 °C	Tc = 105.0 °C
D51 YG868C08R FUJI-ELEC	Tj (max) = 150 °C Pd = 2.88 W Tj = Tc + ((θj-c) × Pd) = 135.6 °C D.F. = 90.4 %	θch-c = 2.0 °C/W ΔTc = 79.8 °C	Tc = 129.8 °C
D52 YG868C08R FUJI-ELEC	Tj (max) = 150 °C Pd = 2.90 W Tj = Tc + ((θj-c) × Pd) = 140.6 °C D.F. = 93.7 %	θch-c = 2.0 °C/W ΔTc = 84.8 °C	Tc = 134.8 °C
PC2 PS2581L1-A(D) NEC	Tj (max) = 125 °C Pc = 7.3 mW Tj = Tc + ((θj-c) × Pc) = 86.6 °C D.F. = 69.3 %	θj-c = 150 °C/W ΔTc = 35.5 °C	Tc = 85.5 °C

Location No.	Vin = 230VAC	Load = 100%	Ta = 50°C
Q1 TK8A65D(Q) TOSHIBA	Tch (max) = 150 °C Pch = 2.51 W Tch = Tc + ((θch-c) × Pch) = 111.7 °C D.F. = 74.5 %	θch-c = 2.78 °C/W ΔTc = 54.7 °C	Pch (max) = 45 W Tc = 104.7 °C
D1 RS405M RECTRON	Tj (max) = 150 °C Pd = 1.32 W Tj = Tc + ((θj-c) × Pd) = 95.7 °C D.F. = 63.8 %	θj-c = 4.2 °C/W ΔTc = 40.2 °C	Tc = 90.2 °C
D51 YG868C08R FUJI-ELEC	Tj (max) = 150 °C Pd = 3.67 W Tj = Tc + ((θj-c) × Pd) = 134.5 °C D.F. = 89.7 %	θch-c = 2.0 °C/W ΔTc = 77.2 °C	Tc = 127.2 °C
D52 YG868C08R FUJI-ELEC	Tj (max) = 150 °C Pd = 3.68 W Tj = Tc + ((θj-c) × Pd) = 139.3 °C D.F. = 92.8 %	θch-c = 2.0 °C/W ΔTc = 81.9 °C	Tc = 131.9 °C
PC2 PS2581L1-A(D) NEC	Tj (max) = 125 °C Pc = 7.3 mW Tj = Tc + ((θj-c) × Pc) = 83.3 °C D.F. = 66.6 %	θj-c = 150 °C/W ΔTc = 32.2 °C	Tc = 82.2 °C

(2-2) Component derating list

.MWS65-24

Location No.	Vin = 115VAC	Load = 100%	Ta = 50°C
Q1 TK8A65D(Q) TOSHIBA	Tch (max) = 150 °C Pch = 1.531 W Tch = Tc + ((θ_{ch-c}) × Pch) = 116.3 °C D.F. = 77.5 %	θ_{ch-c} = 2.78 °C/W ΔTc = 62.1 °C	Pch (max) = 45 W Tc = 112.1 °C
D1 RS405M RECTRON	Tj (max) = 150 °C Pd = 2.1 W Tj = Tc + ((θ_{j-c}) × Pd) = 117.6 °C D.F. = 78.4 %	θ_{j-c} = 4.2 °C/W ΔTc = 58.8 °C	Tc = 108.8 °C
D51 YG982C3R FUJI-ELEC	Tj (max) = 150 °C Pd = 3.2 W Tj = Tc + ((θ_{j-c}) × Pd) = 114.4 °C D.F. = 76.3 %	θ_{ch-c} = 3.0 °C/W ΔTc = 54.8 °C	Tc = 104.8 °C
PC2 PS2581L1-A(D) RENESAS	Tj (max) = 125 °C Pc = 2.3 mW Tj = Tc + ((θ_{j-c}) × Pc) = 79.3 °C D.F. = 63.5 %	θ_{j-c} = 150 °C/W ΔTc = 29.0 °C	Tc = 79.0 °C

Location No.	Vin = 230VAC	Load = 100%	Ta = 50°C
Q1 TK8A65D(Q) TOSHIBA	Tch (max) = 150 °C Pch = 1.49 W Tch = Tc + ((θ_{ch-c}) × Pch) = 94.3 °C D.F. = 62.9%	θ_{ch-c} = 2.78 °C/W ΔTc = 46.2 °C	Pch (max) = 45 W Tc = 96.2 °C
D1 RS405M RECTRON	Tj (max) = 150 °C Pd = 1.9 W Tj = Tc + ((θ_{j-c}) × Pd) = 97.9 °C D.F. = 65.3%	θ_{j-c} = 4.2 °C/W ΔTc = 39.9 °C	Tc = 89.9 °C
D51 YG982C3R FUJI-ELEC	Tj (max) = 150 °C Pd = 2.32 W Tj = Tc + ((θ_{j-c}) × Pd) = 106.56 °C D.F. = 71.0%	θ_{ch-c} = 3.0 °C/W ΔTc = 49.9 °C	Tc = 99.9 °C
PC2 PS2581L1-A(D) RENESAS	Tj (max) = 125 °C Pc = 2.3 mW Tj = Tc + ((θ_{j-c}) × Pc) = 77.0 °C D.F. = 61.6%	θ_{j-c} = 150 °C/W ΔTc = 26.7 °C	Tc = 76.7 °C

3-1. Main components temperature rise ΔT list

MODEL : MWS65-5

(1) Measuring conditions

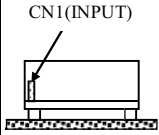
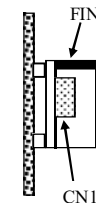
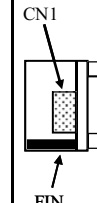
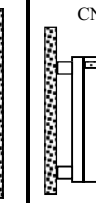
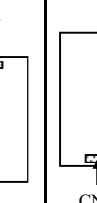
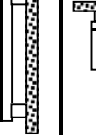
Mounting method (Standard mounting : A)	Mounting A	Mounting B	Mounting C	Mounting D	Mounting E	Mounting F
						
Input voltage	115VAC					
Output voltage	5VDC					
Output current	11A(100%)					

(2) Measuring results

Output derating		ΔT Temperature rise ($^{\circ}\text{C}$)					
		$I_o=100\%$					
		$T_a=50^{\circ}\text{C}$		$T_a=40^{\circ}\text{C}$			
Location No.	Part name	Mounting A	Mounting B	Mounting C	Mounting D	Mounting E	Mounting F
D1	BRIDGE DIODE	55.0	59.1	53.5	61.4	49.1	59.4
D51	SCHOTTKY	79.8	83.1	85.3	85.3	84.3	86.3
D52	SCHOTTKY	84.8	85.8	88.2	80.6	87.5	85.3
PC201	PHOTO COUPLER	43.6	40.6	53.7	57.7	50.2	56.2
PC202	PHOTO COUPLER	35.5	34.1	51.9	50.4	45.0	55.2
L1	Noise Filter coil	48.6	49.8	48.3	54.7	41.8	53.0
L51	CHOKE COIL	56.0	62.8	50.8	53.6	63.9	61.0
C5	E.CAP.	52.7	49.5	54.2	63.6	53.7	57.4
C8	E.CAP.	51.6	49.1	54.5	57.5	52.2	56.5
C51	E.CAP.	52.9	53.9	49.3	53.2	60.9	58.3
T1	TRANS	69.9	71.3	67.7	69.4	71.5	71.3
Q1	MOSFET	59.8	69.1	58.3	65.6	60.4	68.1
A101	CHIP IC	54.2	48.8	57.7	59.5	53.6	65.0
A201	CHIP IC	46.7	41.8	57.1	53.7	51.2	64.0

(1) Measuring conditions

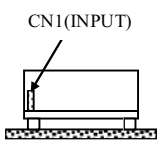
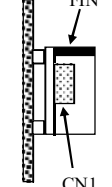
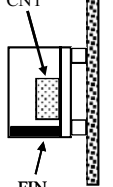
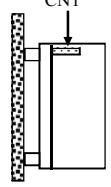
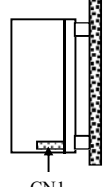
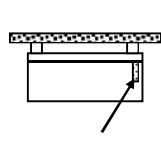
Mounting method (Standard mounting : A)	Mounting A	Mounting B	Mounting C	Mounting D	Mounting E	Mounting F
						
Input voltage	230VAC					
Output voltage	5VDC					
Output current	11A(100%)					

(2) Measuring results

Output derating		ΔT Temperature rise ($^{\circ}\text{C}$)					
		$I_o=100\%$					
		$T_a=50^{\circ}\text{C}$			$T_a=40^{\circ}\text{C}$		
Location No.	Part name	Mounting A	Mounting B	Mounting C	Mounting D	Mounting E	Mounting F
D1	BRIDGE DIODE	40.2	43.8	39.8	48.3	36.0	44.8
D51	SCHOTTKY	77.2	79.6	81.9	82.3	80.9	83.7
D52	SCHOTTKY	81.9	82.7	85.6	77.9	83.8	82.8
PC201	PHOTO COUPLER	38.8	37.4	49.5	55.0	44.7	53.2
PC202	PHOTO COUPLER	32.2	31.7	47.4	48.2	40.3	51.6
L1	Noise Filter coil	35.5	38.1	35.8	44.3	30.2	40.6
L51	CHOKE COIL	52.2	60.4	49.4	52.1	60.5	58.4
C5	E.CAP.	43.8	43.4	46.6	63.8	47.3	50.5
C8	E.CAP.	46.2	44.1	48.7	54.0	45.8	52.9
C51	E.CAP.	52.8	51.0	46.6	51.1	58.3	57.7
T1	TRANS	65.9	66.1	63.8	66.1	65.8	66.7
Q1	MOSFET	54.7	61.4	53.3	59.8	53.4	61.2
A101	CHIP IC	47.6	43.2	50.4	54.7	46.1	57.2
A201	CHIP IC	44.3	40.1	54.2	51.6	47.5	60.3

3-2 . Main components temperature rise ΔT list

MODEL : MWS65-24

(1) Measuring conditions

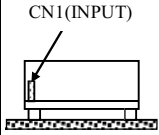
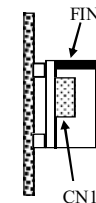
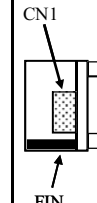
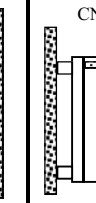
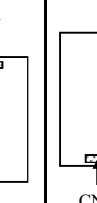
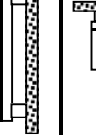
Mounting method (Standard mounting : A)	Mounting A	Mounting B	Mounting C	Mounting D	Mounting E	Mounting F
						
Input voltage	115VAC					
Output voltage	24VDC					
Output current	2.8A(100%)					

(2) Measuring results

Output derating		ΔT Temperature rise ($^{\circ}\text{C}$)					
		$I_o=100\%$					
		$T_a=50^{\circ}\text{C}$		$T_a=40^{\circ}\text{C}$			
Location No.	Part name	Mounting A	Mounting B	Mounting C	Mounting D	Mounting E	Mounting F
D1	BRIDGE DIODE	58.8	59.8	56.6	62.5	54.1	64.2
D51	SCHOTTKY	54.8	56.3	60.4	56.7	61.7	61.6
PC201	PHOTO COUPLER	35.9	31.6	46.6	40.5	43.7	47.5
PC202	PHOTO COUPLER	29.0	25.5	44.9	36.4	38.5	44.6
L1	Noise Filter coil	51.7	49.2	51.5	53.8	45.7	56.7
L51	CHOKE COIL	24.8	27.6	22.2	20.6	36.4	32.5
C5	E.CAP.	50.8	47.4	52.3	51.4	51.3	55.7
C8	E.CAP.	47.5	42.9	51.1	47.1	50.0	53.9
C51	E.CAP.	27.4	26.8	27.8	21.3	38.0	30.3
T1	TRANS	64.3	62.3	63.6	60.7	68.0	66.7
Q1	MOSFET	62.1	65.0	60.3	63.6	64.6	69.8
A101	CHIP IC	46.8	38.5	52.6	46.6	47.3	55.8
A201	CHIP IC	34.3	30.2	45.0	37.9	41.4	48.1

(1) Measuring conditions

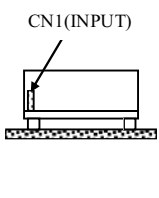
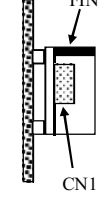
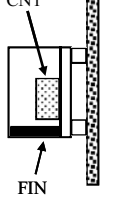
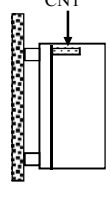
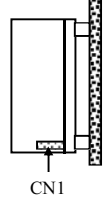
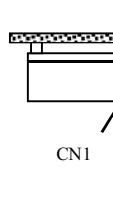
Mounting method (Standard mounting : A)	Mounting A	Mounting B	Mounting C	Mounting D	Mounting E	Mounting F
						
Input voltage	230VAC					
Output voltage	24VDC					
Output current	2.8A(100%)					

(2) Measuring results

Output derating		ΔT Temperature rise ($^{\circ}\text{C}$)					
		$I_o=100\%$					
		$T_a=50^{\circ}\text{C}$			$T_a=40^{\circ}\text{C}$		
Location No.	Part name	Mounting A	Mounting B	Mounting C	Mounting D	Mounting E	Mounting F
D1	BRIDGE DIODE	39.9	41.9	38.5	45.2	36.7	45.4
D51	SCHOTTKY	49.9	51.1	55.0	51.3	55.0	55.8
PC201	PHOTO COUPLER	32.7	29.0	42.1	38.0	37.6	43.2
PC202	PHOTO COUPLER	45.6	43.8	46.9	50.7	42.3	51.3
L1	Noise Filter coil	35.9	36.0	35.8	41.1	31.9	41.4
L51	CHOKE COIL	23.8	26.3	21.4	20.4	31.9	31.3
C5	E.CAP.	41.4	39.4	42.5	44.5	41.2	46.3
C8	E.CAP.	43.2	39.3	45.8	45.4	43.8	49.4
C51	E.CAP.	25.5	25.2	26.3	19.9	34.6	28.4
T1	TRANS	67.0	65.2	65.3	64.3	68.1	69.0
Q1	MOSFET	46.2	50.5	44.1	49.1	47.0	53.0
A101	CHIP IC	41.0	34.0	45.0	42.2	40.2	49.0
A201	CHIP IC	32.7	28.5	41.9	35.4	37.2	45.0

4- 1 . Electrolytic capacitor lifetime

MODEL : MWS65-5

Cooling condition : Convection cooling

Mounting A

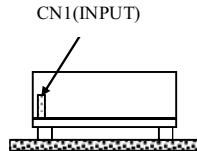

Vin=115VAC

Load (%)	Lifetime (years)		
	Ta= 40°C	Ta= 50°C	Ta= 60°C
40	10.0	10.0	10.0
60	10.0	10.0	10.0
80	10.0	10.0	5.7
100	7.2	3.6	-

Conditions Ta 40°C : ———
 50°C : - - - -
 60°C : ·····

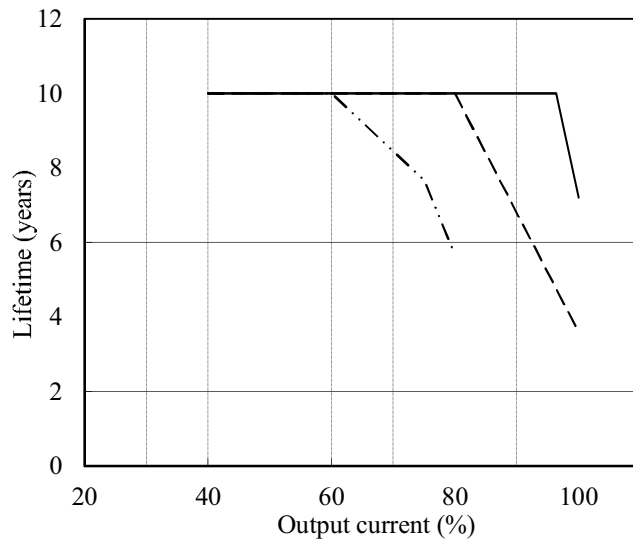

Vin=230VAC

Load (%)	Lifetime (years)		
	Ta= 40°C	Ta= 50°C	Ta= 60°C
40	10.0	10.0	10.0
60	10.0	10.0	6.4
80	10.0	10.0	3.5
100	7.0	3.5	-

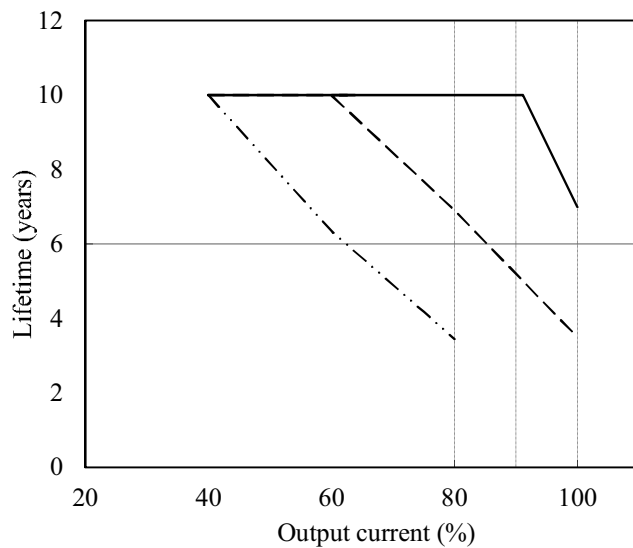

Mounting B

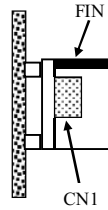

V_{in}=115VAC

Load (%)	Lifetime (years)		
	Ta= 40°C	Ta= 50°C	Ta= 60°C
40	10.0	10.0	10.0
60	10.0	10.0	10.0
80	10.0	10.0	5.3
100	9.0	4.5	-

Conditions Ta 40°C : ———
 50°C : - - - -
 60°C : ·····

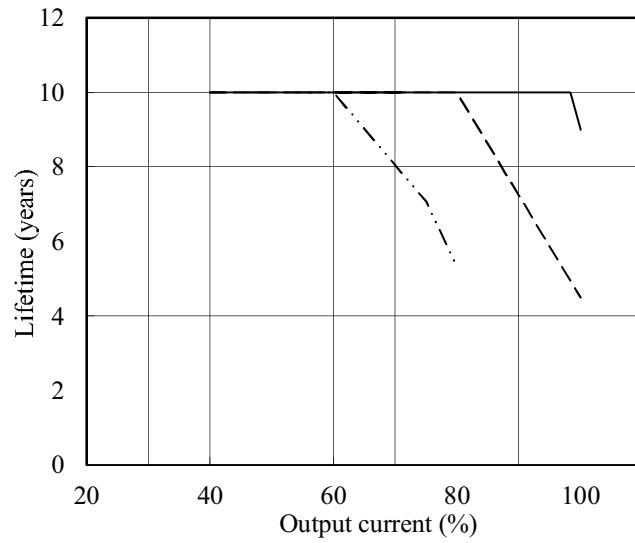

V_{in}=230VAC

Load (%)	Lifetime (years)		
	Ta= 40°C	Ta= 50°C	Ta= 60°C
40	10.0	10.0	10.0
60	10.0	10.0	6.4
80	10.0	6.6	3.3
100	8.6	4.3	-

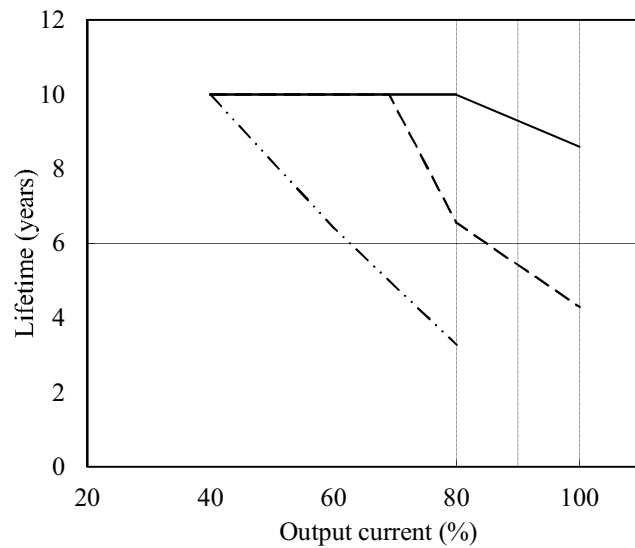

Mounting D

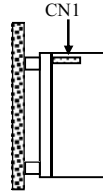

Vin=115VAC

Load (%)	Lifetime (years)		
	Ta= 40°C	Ta= 50°C	Ta= 60°C
40	10.0	10.0	10.0
60	10.0	10.0	7.1
80	10.0	8.6	4.3
100	3.4	-	-

Conditions Ta 40°C : —
50°C : - - -
60°C : - · - · -

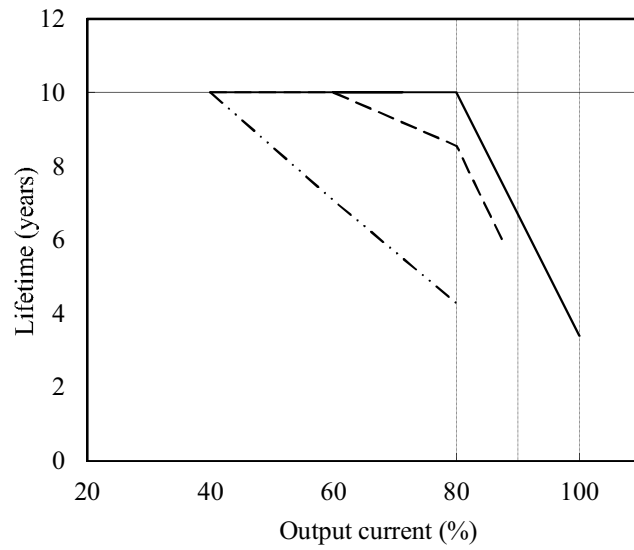

Vin=230VAC

Load (%)	Lifetime (years)		
	Ta= 40°C	Ta= 50°C	Ta= 60°C
40	10.0	10.0	10.0
60	10.0	10.0	8.7
80	10.0	10.0	5.5
100	7.7	3.9	-

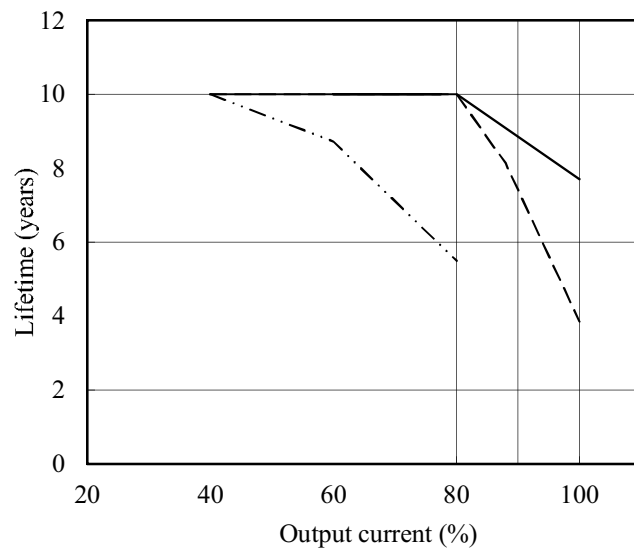

Mounting E

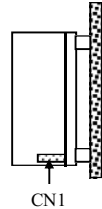

Vin=115VAC

Load (%)	Lifetime (years)		
	Ta= 40°C	Ta= 50°C	Ta= 60°C
40	10.0	10.0	10.0
60	10.0	10.0	10.0
80	10.0	8.5	4.3
100	6.8	3.4	-

Conditions Ta 40°C : —
 50°C : - - -
 60°C : ···

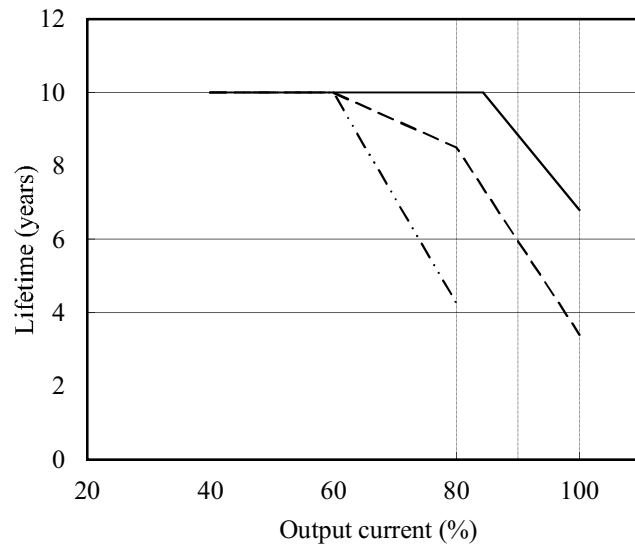

Vin=230VAC

Load (%)	Lifetime (years)		
	Ta= 40°C	Ta= 50°C	Ta= 60°C
40	10.0	10.0	10.0
60	10.0	10.0	10.0
80	10.0	10.0	6.3
100	4.7	-	-

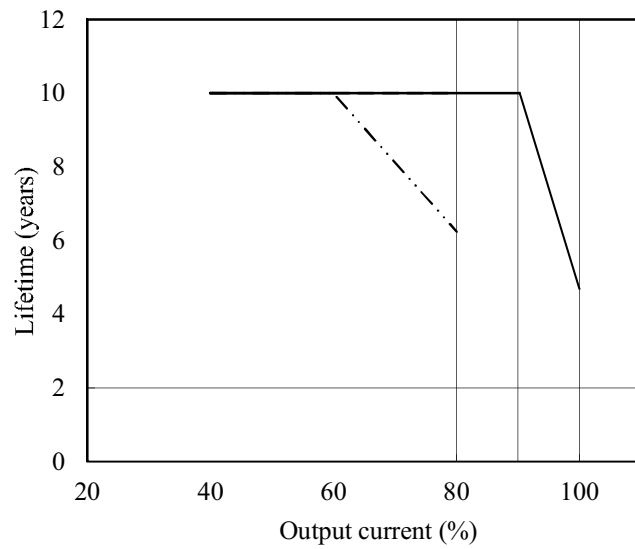

Mounting F

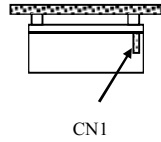

Conditions Ta 40°C : ———
 50°C : - - -
 60°C : - · - ·

Vin=115VAC

Load (%)	Lifetime (years)		
	Ta= 40°C	Ta= 50°C	Ta= 60°C
40	10.0	10.0	10.0
60	10.0	10.0	7.5
80	10.0	7.6	3.8
100	5.2	-	-

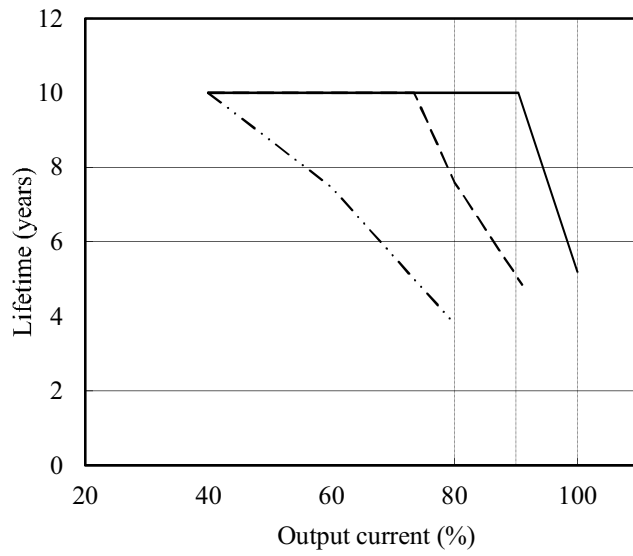

Vin=230VAC

Load (%)	Lifetime (years)		
	Ta= 40°C	Ta= 50°C	Ta= 60°C
40	10.0	10.0	9.9
60	10.0	9.9	5.0
80	10.0	6.1	3.0
100	5.1	-	-

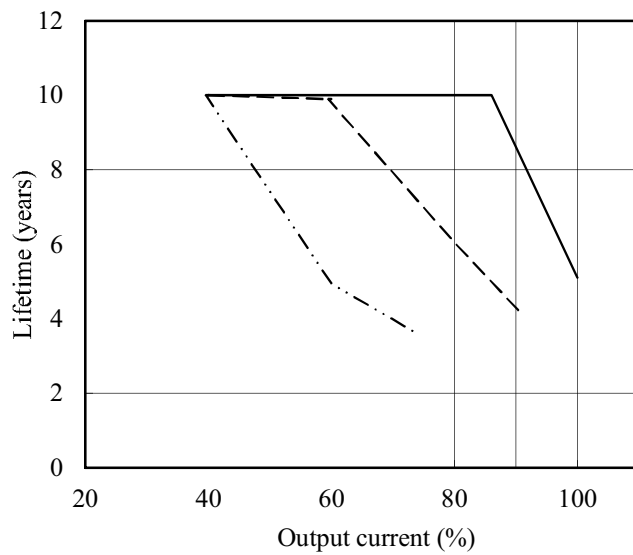

4- 2 . Electrolytic capacitor lifetime

MODEL : MWS65-24

Cooling condition : Convection cooling

Mounting A

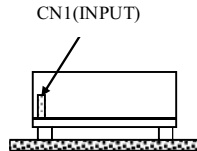

Vin=115VAC

Load (%)	Lifetime (years)		
	Ta= 40°C	Ta= 50°C	Ta= 60°C
40	10.0	10.0	10.0
60	10.0	10.0	10.0
80	10.0	7.0	3.5
100	10.0	5.2	-

Conditions Ta 40°C : ———
 50°C : - - - -
 60°C : ·····

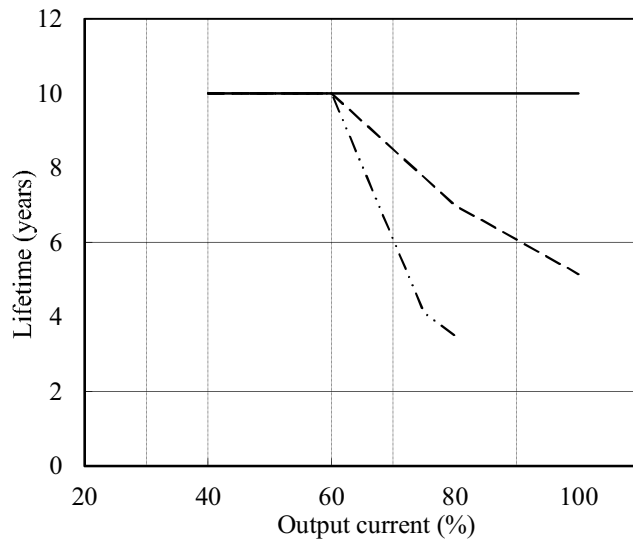

Vin=230VAC

Load (%)	Lifetime (years)		
	Ta= 40°C	Ta= 50°C	Ta= 60°C
40	10.0	10.0	10.0
60	10.0	10.0	7.1
80	10.0	10.0	4.5
100	10.0	6.9	3.5

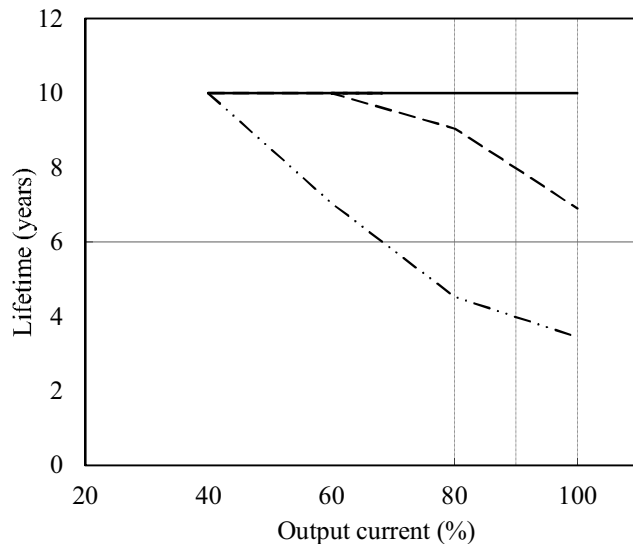

Mounting B

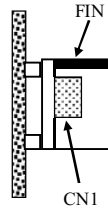

Vin=115VAC

Load (%)	Lifetime (years)		
	Ta= 40°C	Ta= 50°C	Ta= 60°C
40	10.0	10.0	10.0
60	10.0	10.0	7.5
80	10.0	9.7	5.5
100	10.0	7.1	3.5

Conditions Ta 40°C : ———
 50°C : - - - -
 60°C : - · - · -

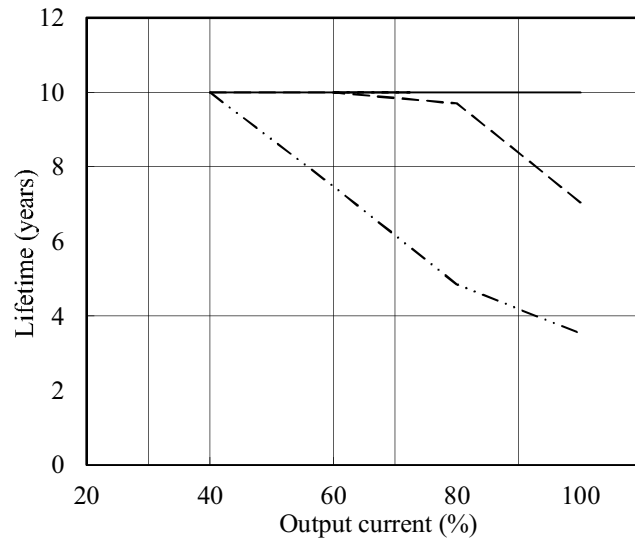

Vin=230VAC

Load (%)	Lifetime (years)		
	Ta= 40°C	Ta= 50°C	Ta= 60°C
40	10.0	10.0	10.0
60	10.0	10.0	8.1
80	10.0	10.0	5.5
100	10.0	9.1	4.5

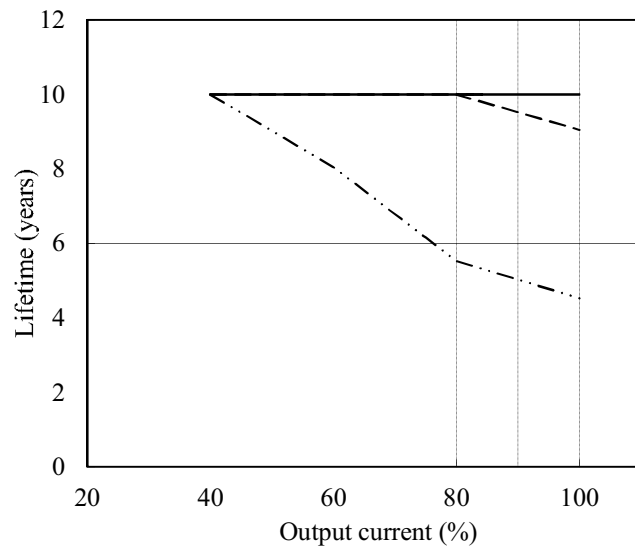

Mounting C

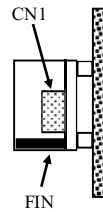

Vin=115VAC

Load (%)	Lifetime (years)		
	Ta= 40°C	Ta= 50°C	Ta= 60°C
40	10.0	10.0	9.5
60	10.0	10.0	5.8
80	10.0	5.8	-
100	8.0	4.0	-

Conditions Ta 40°C : ———
 50°C : - - - -
 60°C : - · - · -

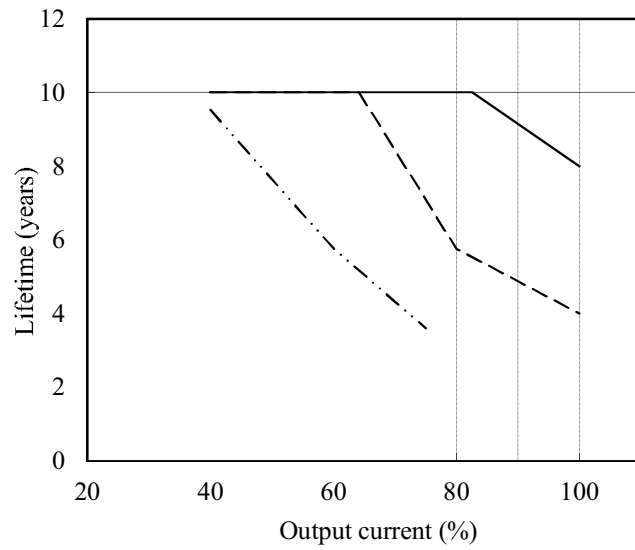

Vin=230VAC

Load (%)	Lifetime (years)		
	Ta= 40°C	Ta= 50°C	Ta= 60°C
40	10.0	10.0	10.0
60	10.0	10.0	7.1
80	10.0	7.9	3.9
100	10.0	5.8	-

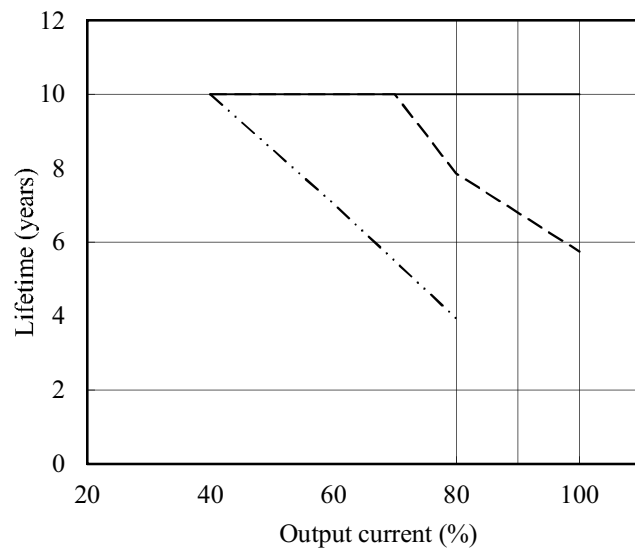

Mounting D

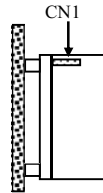

Vin=115VAC

Load (%)	Lifetime (years)		
	Ta= 40°C	Ta= 50°C	Ta= 60°C
40	10.0	10.0	9.0
60	10.0	10.0	5.2
80	10.0	8.7	4.3
100	10.0	5.3	-

Conditions Ta 40°C : ———
 50°C : - - - -
 60°C : - · - · -

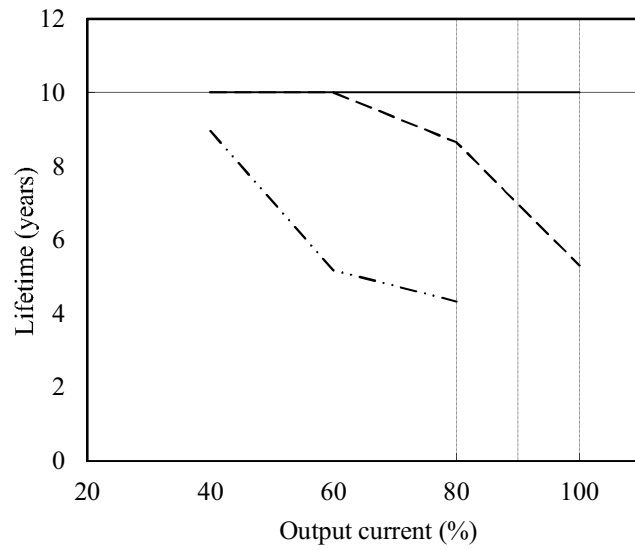

Vin=230VAC

Load (%)	Lifetime (years)		
	Ta= 40°C	Ta= 50°C	Ta= 60°C
40	10.0	10.0	10.0
60	10.0	10.0	6.6
80	10.0	8.7	4.3
100	10.0	6.0	3.0

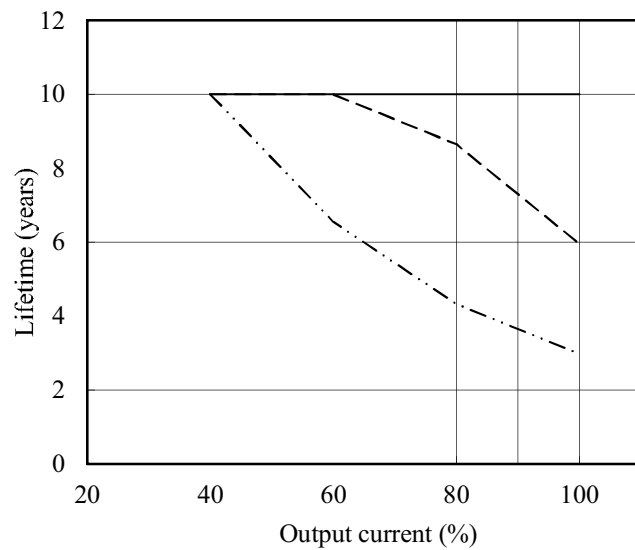

Mounting E

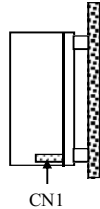

Vin=115VAC

Load (%)	Lifetime (years)		
	Ta= 40°C	Ta= 50°C	Ta= 60°C
40	10.0	10.0	10.0
60	10.0	10.0	5.4
80	9.4	4.7	-
100	8.6	4.3	-

Conditions Ta 40°C : —
50°C : - - -
60°C : ···

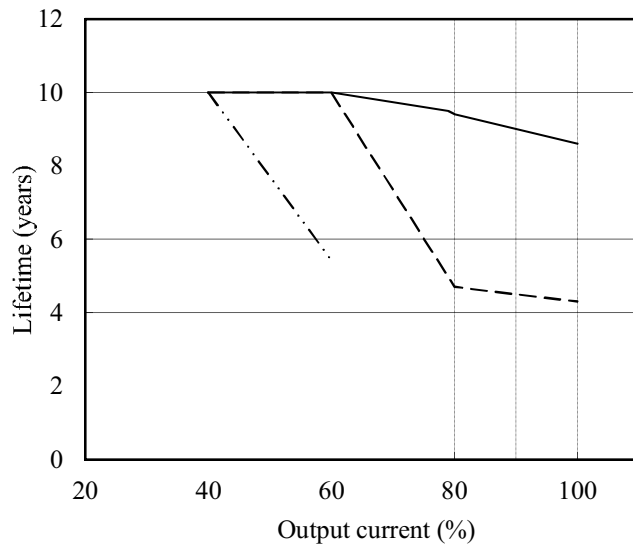

Vin=230VAC

Load (%)	Lifetime (years)		
	Ta= 40°C	Ta= 50°C	Ta= 60°C
40	10.0	10.0	10.0
60	10.0	10.0	6.9
80	10.0	8.9	4.4
100	10.0	5.4	-

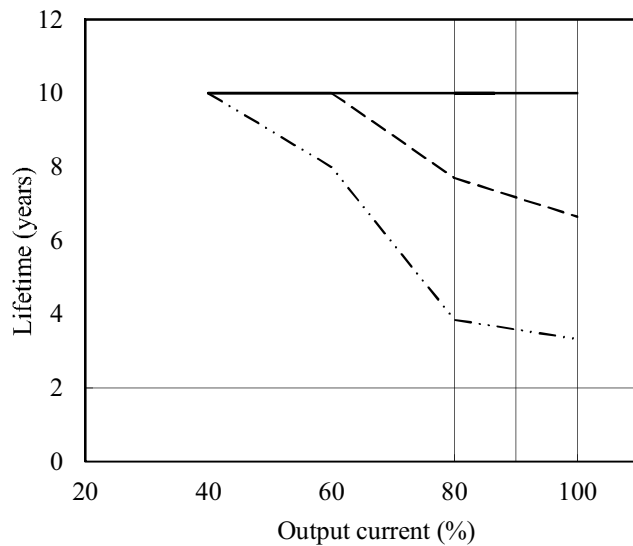

Mounting F

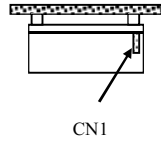

Conditions Ta 40°C : ———
 50°C : - - -
 60°C : - · - · -

V_{in}=115VAC

Load (%)	Lifetime (years)		
	Ta=40°C	Ta=50°C	Ta=60°C
40	10.0	10.0	10.0
60	10.0	10.0	5.4
80	10.0	6.0	3.0
100	6.6	3.3	-

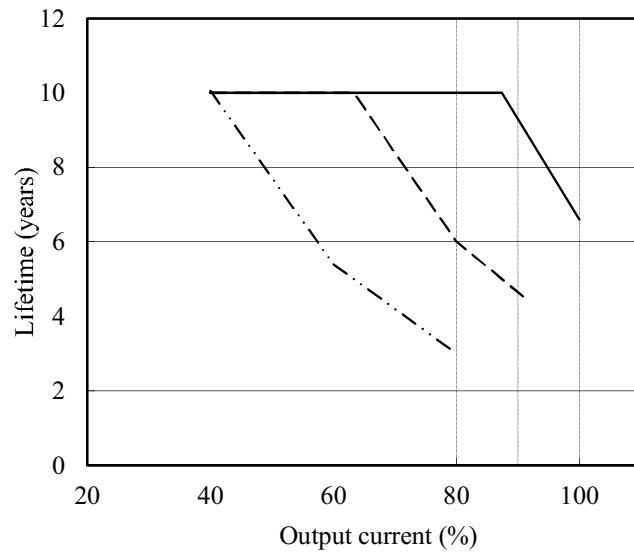

V_{in}=230VAC

Load (%)	Lifetime (years)		
	Ta=40°C	Ta=50°C	Ta=60°C
40	10.0	10.0	10.0
60	10.0	10.0	5.6
80	10.0	7.2	3.6
100	9.0	4.5	-

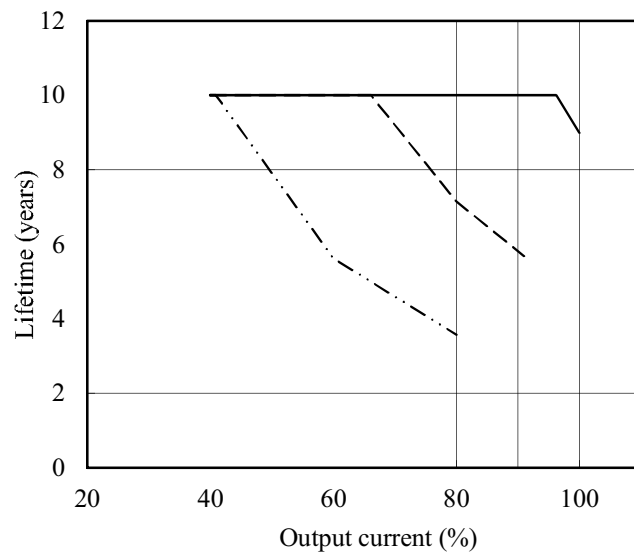

5 . Abnormal test

MODEL : MWS65-5

(1) Test conditions

Input : 115VAC Output : 5V, 11A Ta : 25°C

(2) Test results

(Da : Damaged)

	Test position		Test mode		Test result													Note
	Location No.	Test point	Short	Open	a	b	c	d	e	f	g	h	I	j	k	l		
					Fire	Smoke	Burst	Smell	Red hot	Damaged	Fuse blown	OVP	OCP	No output	No change	Others		
1	Q1	D-S	O							O	O			O			Da:F1/F2/Q1/A101/R1/R116/R118/R119/C103/C104	
2		D-G	O							O	O			O			Da:F1/F2/Q1/A101/R1/R116/R118/R119/C103/C104	
3		G-S	O												O			
4		D		O											O			
5		S		O											O			
6		G		O											O			
7	D1	+ - ~	O							O	O			O			Da:F1/F2	
8		~ - ~	O							O	O			O			Da:F1/F2	
9		~ - -	O							O	O			O			Da:F1/F2	
10		1		O											O			
11		2		O											O			
12		3		O											O			
13	4		O											O				
14	D51	1-2	O											O				
15		2-3	O											O				
16		1-3	O												O			
17		1		O											O			
18		2		O											O			
19	3		O											O				
20	C5		O							O	O			O			Da:F1/F2	
21			O											O				
22	C8		O											O				
23			O											O				
24	C51		O											O				
25			O											O				
26	T1	1-3	O											O				
27		4-5	O											O				
28		6,10-8,9	O											O				
29		1		O										O				
30		3		O										O				
31		4		O										O				
32		5		O										O				
33		6		O											O			
34		8		O											O			
35		9		O											O			
36	10		O											O				

6 . Vibration test

MODEL : MWS65-5

(1) Vibration test class

Frequency variable endurance test

(2) Equipment used

KD-9363-EM : KING DESIGN

(3) Test conditions

• Sweep frequency	: 10~500Hz	• Direction	: X, Y, Z
• Sweep time	: 1.0min	• Sweep count	: 1 hour each
• Acceleration	: Constant 19.6m/s ² (2G)		

(4) Test method

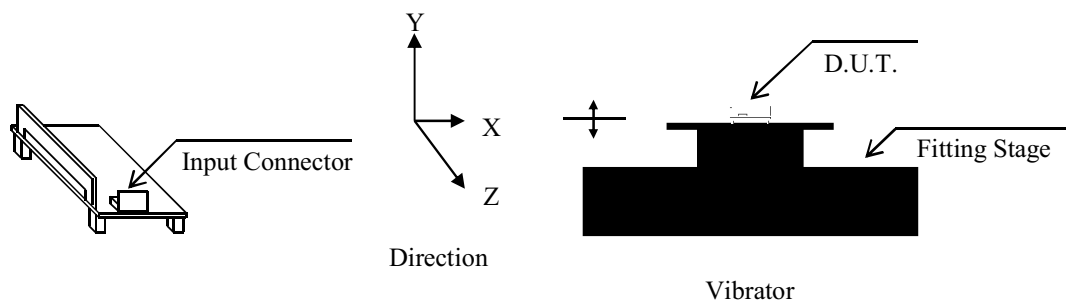

(5) Acceptable conditions

1. Not to be broken
2. Characteristic to be within regulation specification after the test.

(6) Test results

OK

7 . Noise simulate test

MODEL : MWS65-5

(1) Test circuit and equipment

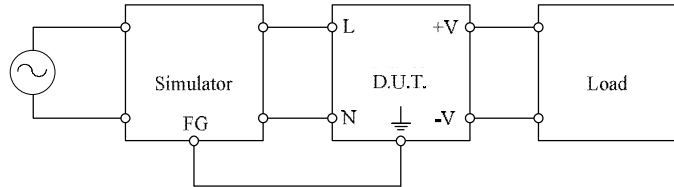

Simulator : INS-410 (Noise Laboratory Co.,LTD)

(2) Test conditions

• Input voltage	: 115, 230VAC	• Noise level	: 0~2kV
• Output voltage	: Rated	• Phase	: 0~360 deg
• Output current	: 0, 100%	• Polarity	: +, -
• Ambient temperature	: 25°C	• Mode	: Common and normal
• Pulse width	: 50~1000ns	• Trigger select	: Line

(3) Acceptable conditions

1. Not to be broken
2. Not to be shut down output
3. No other out of orders

(4) Test results

OK

8 . Thermal shock test

MODEL : MWS65-5

(1) Equipment used

ES-53LS : HITACHI

(2) Test conditions

- Ambient temperature : $-40^{\circ}\text{C} \Leftrightarrow 85^{\circ}\text{C}$
- Test time : Refer to dwg.
- Test cycle : 100 cycles
- Not operating

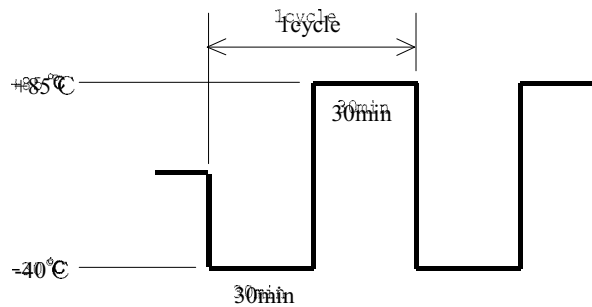

(3) Test method

Before testing, check if there is no abnormal output, then put the D.U.T. in testing chamber, and test it according to the above cycle. 100 cycles later, leave it for 1 hour at the room temperature , then check if there is no abnormal output.

(4) Acceptable conditions

1. Not to be broken
2. Characteristic to be within regulation specification after the test.

(5) Test results

OK