

Short Form Installation User's Manual



Nextys SA. Via Luserte Sud 6, 6572 Quartino – Switzerland
Phone: +41-(0)91 8401446 / 8401448; Fax: +41-(0)91 8401447

Models	DCU20 – High performance DC - UPS		
File No.:	I.M.DCU20	Rev.:	2.0



Use latest device Documentation, Software and Firmware to ensure reliable operation of the system
(downloadable from www.nextys.com)



READ THIS CAREFULLY BEFORE INSTALLATION!	LEGGERE ATTENTAMENTE PRIMA DELL'INSTALLAZIONE!	A LIRE ATTENTIVEMENT AVANT L'INSTALLATION!
<p>Before operating, read this document thoroughly and retain it for future reference.</p> <p>Non-respect of these instructions may reduce performances and safety of the devices and cause danger for people and property. The products must be installed, operated, serviced and maintained by qualified personnel in compliance with applicable standards and regulations.</p> <p>Don't open the device, it does not contain replaceable components, the tripping of the internal fuse (if included) is caused by an internal failure.</p> <p>Don't repair or modify the device, if malfunction or failure should occur during operation, send unit to the factory for inspection. No responsibility is assumed by Nextys SA for any consequences deriving from the use of this material.</p>	<p>Prima dell'installazione, leggere attentamente questo documento istruzioni e conservarle per future consultazioni.</p> <p>L'inosservanza delle presenti istruzioni può compromettere le caratteristiche e la sicurezza dell'apparecchio e causare pericolo per le persone e le cose.</p> <p>Il prodotto deve essere installato, utilizzato e riparato da personale qualificato e nel rispetto delle normative vigenti.</p> <p>Non aprire il prodotto, esso non contiene componenti sostituibili, il guasto del fusibile interno (se previsto) è causato da un guasto interno.</p> <p>Non tentare di riparare o modificare il prodotto, se durante il funzionamento si verificano guasti o anomalie, inviarlo al produttore per il controllo.</p> <p>Nextys SA non si assume nessuna responsabilità per qualunque conseguenza derivante dall'uso di questo materiale.</p>	<p>Lire ces instructions avant l'installation, conserver ce manuel pour référence future.</p> <p>Défaut de se conformer à ces instructions peut affecter les caractéristiques et la sécurité du dispositif, et causer du danger aux personnes ou aux biens.</p> <p>Les produits doivent être installés, exploités et entretenus par du personnel qualifié et en conformité avec les règlements.</p> <p>N'ouvrez pas le produit, il ne contient aucune pièce réparable, le déclenchement du fusible interne (le cas échéant) est causé par un défaut interne. Ne pas essayer de réparer ou modifier le produit ; si des défaillances se produisent pendant le fonctionnement, retourner le produit au fabricant pour inspection. Nextys SA n'assume aucune responsabilité des conséquences éventuelles découlant de l'utilisation des produits.</p>
CAUTION	ATTENZIONE	AVVERTISSEMENT
<p>RISK OF BURNS, EXPLOSION, FIRE, ELECTRICAL SHOCK, PERSONAL INJURY.</p> <p>Never carry out work on live parts! Danger of fatal injury! The product's enclosure may be hot, allow time for cooling product before touching it. Do not allow liquids or foreign objects to enter into the products.</p> <p>To avoid sparks, do not connect or disconnect the device before having previously turned-off input power and wait for internal capacitors discharge (minimum 1 minute).</p>	<p>RISCHIO USTIONI, ESPLOSIONE, INCENDIO, SCOSSA, LESIONI GRAVI.</p> <p>Non effettuare mai operazioni sulle parti sotto tensione! Pericolo di lesioni letali! Il contenitore può scottare, lasciar quindi raffreddare il dispositivo prima di toccarlo. Non far entrare liquidi o oggetti estranei nel dispositivo.</p> <p>Per evitare scintille, non collegare o scollegare l'apparecchiatura prima di avere tolto tensione di ingresso e prima che sia avvenuta la scarica dei condensatori interni (min. 1 minuto).</p>	<p>RISQUE DE BRULURES, EXPLOSION, INCENDIE, ELECTROCUTION, DOMMAGE AUX PERSONNES.</p> <p>Ne jamais effectuer des opérations sur les parties sous tension! Danger de mort! Le boîtier peut produire des brûlures, le laisser refroidir avant de toucher l'appareil. Ne faire pas pénétrer des liquides ou des corps étrangers dans l'appareil. Pour éviter des étincelles, ne pas connecter ou déconnecter l'équipement jusqu'à ce que la tension d'entrée a été supprimée et avant qu'il n'ait eut lieu la décharge des condensateurs internes (minimum 1 minute).</p>
INTENDED USE	USO PREVISTO	UTILISATION
<p>These are isolated devices suitable for SELV and PELV circuitry and are designed to be mounted on DIN rail and installed inside a protective enclosure. They are intended for general use such as in industrial control, communication, and instrumentation equipment.</p> <p>Don't use these devices in applications where malfunction may cause injury or death.</p>	<p>I dispositivi sono isolati, adatti per applicazioni SELV e PELV, sono dotati di aggancio per il montaggio su guida DIN all'interno di quadri elettrici o contenitori di protezione, per l'utilizzo con controllori industriali, unità di comunicazione o apparecchi di misura.</p> <p>Non utilizzare in applicazioni in cui un eventuale guasto può comportare rischio di lesioni o di morte.</p>	<p>Les produits sont isolés, appropriés pour les circuits TBTS et TBTP et sont équipés d'un crochet pour montage sur rail DIN dans des armoires ou conteneurs de protection, pour utilisation avec les contrôleurs industriels, des modules de communication ou des unités de mesure.</p> <p>Ne pas utiliser ces dispositifs dans une application où un dysfonctionnement pourrait entraîner le risque des blessures ou de mort.</p>
ENVIRONMENTAL CHARACTERISTICS	CARATTERISTICHE AMBIENTALI	CARACTÉRISTIQUES ENVIRONNEMENTALES
<p>Installation in a Pollution Degree 2 environment, Overvoltage Category I, according to IEC60664-1.</p> <p>Do not use in wet area or subject to moisture.</p> <p>Carefully recycle the product and related batteries according to local regulations.</p>	<p>Usare in ambienti con Grado di Inquinamento 2 e Categoria di Sovratensione I, secondo IEC60664-1.</p> <p>Non far funzionare l'apparecchio in un ambiente umido o soggetto a formazione di condensa. Riciclare il prodotto e le batterie collegate, nel rispetto delle normative locali vigenti.</p>	<p>Utiliser les produits dans des environnements avec degré de pollution 2, catégorie de surtension I selon IEC60664-1.</p> <p>Ne pas employer l'appareil dans un environnement humide ou soumis à la condensation. Recycler les produits et les batteries, conformément à la réglementation locale.</p>

Declaration of Conformity				
		<p>NEXTYS SA. Via Luserte Sud 6, 6572 Quartino - Switzerland Phone: +41-(0)91 840 14 46 / 840 14 48; Fax: +41-(0)91 840 14 47 E-mail: info@nextys.com</p>		
<p>This Declaration of Conformity is suitable to the European Standard EN45014 "General criteria for supplier's declaration of conformity". We declare under our sole responsibility that the device included in this box, has passed all processing inspections and the final test and it is in conformity with the product requirements, including all reference codes and supply specifications.</p>				
<p>ROHS compliance: the product respects the EC requirements related to ROHS substances, according to "Restriction of Hazardous Substances" as per document 2011/65/UE REACH compliance: the product respects the EC requirements related to REACH SVHC directive (2015) Note: all the reported information comes from our suppliers, NEXTYS SA. has not run any test to evaluate if the specific elements are present.</p>				
<p>All indicated devices are designed according to the latest Reference standards, if not expressly indicated through the official documents or files, they have been tested through our internal pre-compliance testing. Consult directly on www.nextys.com the reference standards applied to each model.</p>				
Code	Description			
DCU20	DC-UPS module IN 12...28Vdc – 20A / OUT 12...28Vdc – 20A			
Certifications and approvals				
Reference standards	<p>2014/35/EU (2014) (Low Voltage Directive) 2014/30/EU (2014) (EMC directive) EN60950-1 (Safety Standards) UL508 (Certified – IND.CONT.EQ. 4WX9 file no. E356563) IEC60664-1 (Safety Standards) EN50178 (Safety Standards) EN61000-6-2 (Generic immunity standard for industrial environments) - EN61000-4-2 (Electrostatic discharge immunity test) - EN61000-4-3 (Radiated, radio-frequency, electromagnetic field immunity test) - EN61000-4-4 (Electrical fast transient/burst immunity test) - EN61000-4-5 (Surge immunity test) EN61000-6-2 (Generic emission standard for industrial environments) - EN55011 (CISPR11 - EMC)</p>			
Date:	08.08.2019		The product manager	
Place:	Quartino, Switzerland		 Marius Ciorica	

System Description

The DCU20 is a microprocessor controlled DC UPS rated 20A (*rating of the power supply connectable to the input*) usable in systems with a nominal voltage between 12V and 28V. The DCU20 monitors the voltage coming from a DC power supply and in case of power failure a backup battery is connected to the load. In normal condition the battery is kept charged by an integrated battery charger supporting various battery chemistries such Lead-Acid, NiMH, NiCd and Lithium.

Connections: the device is equipped with pluggable screw terminals or screw type header. To avoid sparks, do not connect or disconnect the connectors before having previously turned-off input power and waited for internal capacitors discharge (minimum 1 minute).

In order to comply with UL certification use appropriate copper cables of indicated cross section, designed for an operating temperature of:

60°C for ambient up to 45°C

75°C for ambient up to 60°C

90°C for ambient up to 70°C.

Strip the connecting ends of the wires according to the indication as shown below and ensure that all strands of a stranded wire enter the terminal connection.

Connections and User interface

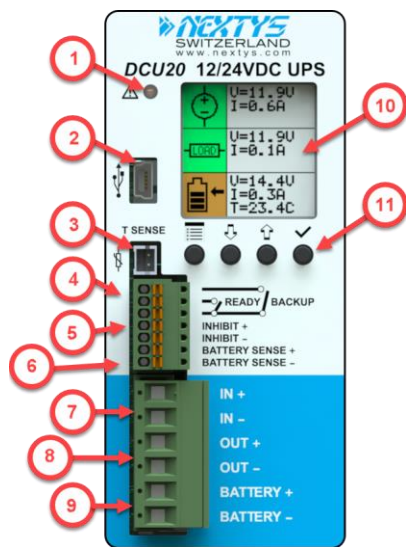

- 1. Alarm LED indicator:** ON when the unit is in backup. Blinks at 1Hz rate in case of error.
- 2. USB Port:** Used to connect a PC running POWERMASTER or custom application for remote monitoring and controlling. Firmware update is also possible through USB connection.
- 3. Temperature sensor:** Optional temperature sensor (P/N: WNTC-2MT) to measure the battery temperature for protection and temperature compensated charge method.
- 4. Relays dry contacts:** 2 relays are present for remote monitoring.
- 5. INHIBIT input:** A signal between 5VDC and 30VDC applied to this input inhibits the backup function; this input is programmable to be active high or active low.
- 6. BATTERY SENSE connection:** Used to accurately sense the battery voltage by considering the cables voltage drop. It is recommended to use this input when the battery internal resistance measurement is needed.
- 7. Input connection:** 2 poles are provided for input connection. This must be connected to a power supply rated 12...28VDC with a maximum rated current of 20A.
- 8. Output connection:** 2 poles are provided for output connection. It must be connected to the load to be backed up with a maximum rated current of 20A.
- 9. Battery connection:** 2 poles are provided for battery connection. This must be connected to the battery. Although the unit is protected, please respect the correct polarity.
- 10. Display area:** provides information regarding the device status.
- 11. Control keys:** 4 push buttons are provided to navigate through the menus and to select the various functions.

Operating MODE

UPS Mode

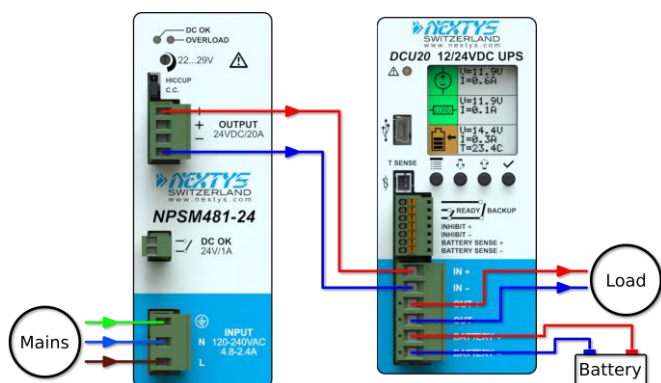

UPS Mode:

In UPS mode the DCU20 protects a load from unwanted power interruption in case of mains failure. An example of UPS connection is given on the side. When the input is present DCU20 acts as a bypass, connecting the input to the output via the input switch. Meanwhile, if required, the battery is charged. During bypass there is no voltage conversion, therefore the output supply voltage is equal to the input voltage. In case of power outage, the DCU20 takes energy directly from the battery.

Backup:

The system is in backup mode if the supply for the output is sourced from the battery (input supply missing). During backup the battery is monitored continuously to prevent over discharge. A programmable backup timer is also implemented in order to fix a maximum backup time during power outages. This allows preserving the battery life and shortening the recharge time, avoiding discharging the battery when not needed. During backup the internal Coulomb counter is used to give an estimation of the residual charge of the battery, this information is given to the user on the LCD in form of remaining % and through the ready relay which starts toggling at 1Hz once the battery charge is < 20%.

Battery charger:

The battery charger supports **various chemistries** such Lead-Acid, Nickel, Lithium and Super-capacitors. Other charging algorithms can be implemented by request (contact factory). The battery charger automatically reduces the current to avoid exceeding the maximum input current in case of high current load.

⚠ Warnings:

- In order to avoid potentially hazardous situations including fire hazard, safety recommendations must be followed. Only authorized staff can install the unit.
- For Lithium cells the balancing and protection circuit must be included in the battery pack.
- For Nickel batteries the use of the external temperature sensor is mandatory. The sensor must be placed in contact with the battery.

Additional Functions

Coulomb Counter:

DCU20 measures the current flowing from / to the battery to keep track of the capacity available on the battery. The capacity is measured in Ampere Hour [Ah]. The value shown is based on the following assumptions:

- The value shown is just informative and does not represent the real state of charge of the battery in some circumstances, for example if the battery is damaged.
- When the battery is connected for the first time or the system starts from OFF, the system assumes the battery is fully discharged and start with 0Ah counter.
- Once the battery is fully charged the system sets the counter to the nominal capacity specified by the user.

Cold Start:

The cold start is a procedure that allows turning ON the UPS without the input power. This procedure is used to turn ON the UPS to operate during a power interruption. This practice is also a method to see if the battery connected to the DCU20 is functional. In cold start the DCU20 will remain ON for at least 60 seconds independently from the battery voltage being under the deep discharge threshold, the inhibit input and the backup timer. After the first 60 seconds the device stays ON until the battery is not deep discharged, the backup timer is not expired or the inhibit input is not active.

If the input supply returns during cold start the device reverts to normal operation.

To cold start the DCU20:

- Press and hold simultaneously the menu button and OK button until you see the welcome message on the screen. On the status screen the input voltage status is indicated as "Cold start".
- Release the buttons.

PC shutdown and automatic restart:

PC shutdown: In case the DCU20 is used to supply a PC it is possible to automatically shut down the PC after an adjustable time of backup. For this the PC must run the





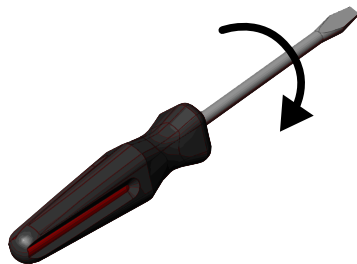
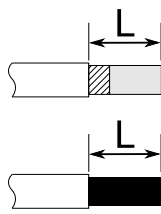

POWERMASTER application (provided free) and must be connected through USB. Optionally **POWERMASTER** can call a task on the PC before shutting down, for example to backup some sensitive data.

Automatic restart: DCU20 is able to automatically restart a PC which was powered OFF by mistake, for example in case of the Operating System (OS) crash. The user may adjust an output current threshold and a timer used for detecting the PC OFF status. In order to restart the PC the DCU20 toggles the output OFF and then ON again. User must enable in the PC BIOS the automatic start in case of supply ON.

Recommended connecting cable

	<p>Recommended Tightening torque</p> <p>Input / output connections 0.5-0.6Nm 4.42-5.30 lbf in</p> <p>Auxiliary connections Insertion force per pole Max 3N or 0.674 lbf</p> <p>Withdrawal force per pole Min 1.5N or 0.337 lbf</p>		<p>Input / output connections Solid: 2.5mm² / 12AWG Stranded: 2.5mm² / 12AWG L: 6.0-7.5mm / 0.24-0.30in</p> <p>Auxiliary connections Solid: 0.5mm² / 20AWG Stranded: 0.5mm² / 20AWG L: 7.0-8.0mm / 0.27-0.315in</p>
--	---	--	---

User Interface

Symbols	Name	Function / Description
	MENU Key	Scrolls between menus.
	DOWN Key	Scrolls down menus and values.
	UP Key	Scrolls up menus and values.
	OK Key	Confirms selection.
	INPUT	The measured input voltage and current is shown in this section.
	OUTPUT	The measured output voltage and current is shown in this section.
	BATTERY	The battery voltage, current, temperature, resistance and charge are shown in this section. In case of problems with the battery the background color of the symbol changes from green to red and a message with the cause appears. During charging and discharging the symbol background color changes to orange and the number of bars drawn inside reflects the charge status. During discharging and charging an arrow drawn beside the symbol reflects the direction of the current flowing through the battery, pointing towards the battery during charging.

Power ON screen:

This screen is shown at power ON. It shows the device name, serial number and firmware version.

Status:

This is the default view where the user can find the most relevant information about the device status. The system always falls back to this view after 60s of inactivity (no key pressed).

Settings:

All the device settings are configurable from this menu. Use the UP/DOWN KEY to navigate through the parameters. Press the OK KEY to enter/exit the editing mode. In editing mode use the UP/DOWN KEY to change the highlighted value.

Info:

Device information such as firmware version, serial number and device name is visible from this menu.

Logs:



All the alarms and event are logged in a circular buffer and visible from this screen. Use the UP/DOWN KEY to navigate through the logs.

Wizard:

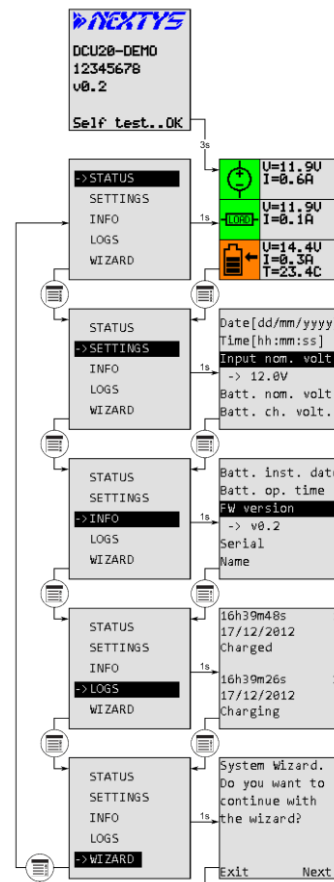
The wizard helps the user to configure the system through a series of screens.

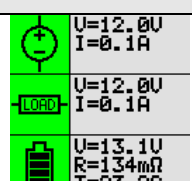
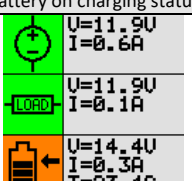
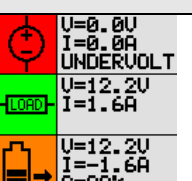

MODE displayed

Status OK	Mains OK Battery on charging status	Backup mode	Alarm screen
			 Battery voltage too low. Check battery.

LOGS	
	<pre> 10h56m00s 6 18/12/2012 Power On #35 09h42m40s 7 18/12/2012 Charged </pre>
<ol style="list-style-type: none"> Date / Time: date and time at which the log occurred. Message: type of event or alarm occurred. Index: incremental event index. 	
<p>Every event is logged in the device FLASH memory. From the log menu the user can view their history. Use the UP/DOWN KEYS to navigate between logs, 2 logs are visible simultaneously on the LCD. Logs are of 3 different kinds: info, alarms and events. All info and alarms have an associated Modbus field with the current status (0 if inactive or 1 if active). For info and alarms a log is generated at each status transaction. In case of active alarm the front LED and the buzzer turn ON.</p>	

Alarms		
Type	LCD name	Description
Input Undervoltage Start	IUVS	The measured input voltage is lower than the alarm threshold. The threshold is calculated taking the lowest value between the input nominal voltage and the battery nominal voltage - 10%
Input Undervoltage End	IUVE	The measured input voltage returns above the alarm threshold.
Input Overvoltage Start	IOVS	The measured input voltage exceeds the alarm threshold. The threshold is the input nominal voltage +30%.
Input Overvoltage End	IOVE	The measured input voltage returns below the alarm threshold.
Input Overload Start	IOLS	The measured input current exceeds the alarm threshold. The alarm threshold is set to 22A.
Input Overload End	IOLE	The measured input current returns below the alarm threshold.
Output Overload Start	OOLS	The measured output current exceeds the alarm threshold. The alarm threshold is set to 22A.
Output Overload End	OOLE	The measured output current returns below the alarm threshold.
Battery Undervoltage Start	BUVS	The measured battery voltage is lower than the alarm threshold. The threshold is 80% of the battery deep discharge voltage.
Battery Undervoltage END	BUVE	The measured battery voltage returns above the alarm threshold.
Battery Low Start	BLOWS	During discharge the measured battery voltage is lower than the battery low voltage threshold.
Battery Low End	BLOWE	The measured battery voltage returns above the battery low voltage threshold.
Battery Overvoltage Start	BOVS	The measured battery voltage exceeds the alarm threshold. The threshold is the battery charge voltage + 10%.
Battery Overvoltage End	BOVE	The measured battery voltage returns below the alarm threshold.
Battery Overtemperature Start	BOTS	The measured battery temperature exceeds the alarm threshold. The threshold is the battery maximum temperature.
Battery Overtemperature End	BOTE	The measured battery temperature returns below the alarm threshold.
Battery Undertemperature Start	BUTS	The measured battery temperature is lower than the alarm threshold. The threshold is the battery minimum temperature
Battery Undertemperature End	BUTE	The measured battery temperature returns above the alarm threshold.
Battery RI too High Start	Ri high start	The measured battery internal resistance exceeds the alarm threshold. The threshold is the battery nominal internal resistance + maximal internal resistance variation.
Battery RI too High End	Ri high end	The measured battery internal resistance returns below the alarm threshold.
SHORT CIRCUIT	Short circ.	A short circuit has been detected on the output.
Battery ERROR	Batt. error	The DCU20 was unable to charge the battery correctly.

Events		
Type	LCD name	Description
Power ON	Power on	Triggered at device power ON.
Power Off	Power off	Triggered when DCU20 powers OFF.
Battery Charging	Charging	Triggered when the DCU20 starts charging the battery.
Battery Charged	Charged	Triggered when the DCU20 finishes charging the battery. The battery is fully charged.
Battery Discharging	Discharging	Triggered when the DCU20 enters the backup mode.
Inhibit start	Inhibit start	Triggered when the inhibit input toggles from false to true.
Inhibit end	Inhibit end	Triggered when the inhibit signal toggles from true to false.

Mounting / Dismounting Instructions

For DIN rail mounting according to IEC 60715 TH35-7.5(-15). Mounting as shown in figure, with input terminals on lower side, with suitable cooling and maintaining a proper distance between adjacent devices as specified in the User manual.

Mounting		
<ol style="list-style-type: none"> Tilt the unit slightly backwards. Fit the unit over the top edge of the rail. Slide it downward until it hits the stop. Press against the bottom for locking. 	<p>1</p>	<p>2</p>
	<p>3</p>	<p>4</p>

Dismounting		
<ol style="list-style-type: none"> Pull down the slide clamp lever. Tilt the unit upward. Unhook the unit from the rail. 	<p>1 & 2</p>	<p>3</p>