

OR20 – 20A Universal Active ORing Controller

■ **Main Features:**





- Ultra Compact Redundancy Module
- Wide input voltage range 12...85Vdc (on a single model)
- 20A Max
- Extremely low loss up to 99% efficiency
- Pluggable connectors
- Hot pluggable
- Up to 70°C operating temperature with no derating



INDEX	
Installation Requirements	Page 2
Declaration of Conformity	2
User Instructions	3
Connections	3
Dimensions	3
Distances	3
Mounting	4
Dismounting	4
Set-up	5
Environment	5
Accessory Device	5

READ THIS CAREFULLY BEFORE INSTALLATION!	LEGGERE ATTENTAMENTE PRIMA DELL'INSTALLAZIONE!	A LIRE ATTENTIVEMENT AVANT L'INSTALLATION!
<p>Before operating, read this document thoroughly and retain it for future reference.</p> <p>Non-respect of these instructions may reduce performances and safety of the devices and cause danger for people and property.</p> <p>The products must be installed, operated, serviced and maintained by qualified personnel in compliance with applicable standards and regulations.</p> <p>Don't open the device, it does not contain replaceable components, the tripping of the internal fuse (if included) is caused by an internal failure.</p> <p>Don't repair or modify the device, if malfunction or failure should occur during operation, send unit to the factory for inspection. No responsibility is assumed by Nextys SA for any consequences deriving from the use of this material.</p>	<p>Prima dell'installazione, leggere attentamente questo documento istruzioni e conservarle per future consultazioni. L'inosservanza delle presenti istruzioni può compromettere le caratteristiche e la sicurezza dell'apparecchio e causare pericolo per le persone e le cose.</p> <p>Il prodotto deve essere installato, utilizzato e riparato da personale qualificato e nel rispetto delle normative vigenti.</p> <p>Non aprire il prodotto, esso non contiene componenti sostituibili; il guasto del fusibile interno (se previsto) è causato da un guasto interno. Non tentare di riparare o modificare il prodotto, se durante il funzionamento si verificano guasti o anomalie, inviarlo al produttore per il controllo.</p> <p>Nextys SA non si assume nessuna responsabilità per qualunque conseguenza derivante dall'uso di questo materiale.</p>	<p>Lisez ces instructions avant l'installation, conservez ce manuel pour référence future.</p> <p>Défaut de se conformer à ces instructions peut affecter les caractéristiques et la sécurité du dispositif de danger et de causer aux personnes ou aux biens.</p> <p>Les produits doivent être installés, exploité et entretenus par personnel qualifié et en conformité avec les règlements.</p> <p>N'ouvrez pas le produit, il ne contient aucune pièce réparable, le déclenchement du fusible interne (le cas échéant) est causé par un défaut interne. Ne pas essayer de réparer ou modifier le produit ; si des défaillances se produisent pendant le fonctionnement ou les dysfonctionnements, le retourner au fabricant pour inspection. Nextys SA n'assume aucune responsabilité des conséquences éventuelles découlant de l'utilisation des produits.</p>
CAUTION	ATTENZIONE	AVVERTISSEMENT
<p>RISK OF BURNS, EXPLOSION, FIRE, ELECTRICAL SHOCK, PERSONAL INJURY.</p> <p>Never carry out work on live parts! Danger of fatal injury! The product's enclosure may be hot, allow time for cooling product before touching it. Do not allow liquids or foreign objects to enter into the products.</p> <p>To avoid sparks, do not connect or disconnect the device before having previously turned-off input power and wait for internal capacitors discharge (minimum 1 minute).</p> <p>Radio interference! This is an electrical appliance according to EN55032, class A. It may cause radio interference in residential areas.</p>	<p>RISCHIO USTIONI, ESPLOSIONE, INCENDIO, SCOSSA, LESIONI GRAVI.</p> <p>Non effettuare mai operazioni sulle parti sotto tensione! Pericolo di lesioni letali! Il contenitore può scottare, lasciar quindi raffreddare il dispositivo prima di toccarlo. Non far entrare liquidi o oggetti estranei nel dispositivo.</p> <p>Per evitare scintille, non collegare o scollegare l'apparecchiatura prima di avere tolto tensione di ingresso e prima che sia avvenuta la scarica dei condensatori interni (min. 1 minuto).</p> <p>Interferenza radio! Questo apparecchio è un dispositivo di classe A secondo lo standard EN55032. Può causare interferenze radio nelle aree residenziali.</p>	<p>RISQUE DE BRULURES, EXPLOSION, INCENDIE, ELECTROCUTION, DOMMAGE AUX PERSONNES.</p> <p>Ne jamais effectuer des opérations sur les parties sous tension! Danger de mort! Le récipient peut produire des brulures, le laisser refroidir avant de toucher l'appareil. Ne faites pas pénétrer des liquides ou des corps étrangers dans l'appareil. Pour éviter des étincelles, ne pas connecter ou déconnecter l'équipement jusqu'à ce que vous avez supprimé la tension d'entrée et avant qu'elle n'ait lieu de décharge des condensateurs internes (minimum 1 minute).</p> <p>Perturbations radioélectriques! Cet appareil est un dispositif de catégorie A selon le standard EN55032. Il peut causer des perturbations radioélectriques dans les zones résidentielles.</p>

DECLARATION OF CONFORMITY

		<p>NEXTYS SA. Via Luserte Sud 6, 6572 Quartino - Switzerland Phone: +41-(0)91 840 14 46 / 840 14 48; Fax: +41-(0)91 840 14 47 E-mail: info@nextys.com</p>		
<p>This Declaration of Conformity is suitable to the European Standard EN45014 "General criteria for supplier's declaration of conformity". We declare under our sole responsibility that the device included in this box, has passed all processing inspections and the final test and it is in conformity with the product requirements, including all reference codes and supply specifications.</p>				
<p>ROHS compliance: the product respects the EC requirements related to ROHS substances, according to "Restriction of Hazardous Substances" as per document 2011/65/UE REACH compliance: the product respects the EC requirements related to REACH SVHC directive (2015) Note: all the reported information comes from our suppliers, NEXTYS SA. has not run any test to evaluate if the specific elements are present.</p>				
<p>All indicated devices are designed according to the latest Reference standards, if not expressly indicated through the official documents or files, they have been tested through our internal pre-compliance testing. Consult directly on www.nextys.com the reference standards applied to each model.</p>				
<p>Code OR20</p>	<p>Description 20A Universal Active ORing Controller 12...85Vdc</p>			
<p>Certifications and approvals</p>				
<p>Reference standards</p>	<p>2014/35/EU (2014) 2014/30/EU (2014) EN61010-1 EN61010-2-201 UL508 EN61000-6-2 - EN61000-4-2 - EN61000-4-3 - EN61000-4-4 - EN61000-4-5 - EN61000-4-11 EN61000-6-4 - EN55022 - EN55011</p>	<p>(Low Voltage Directive) (EMC directive) (Safety Standard) (Safety Standard) (Safety Standard) (Safety Standard) (Generic immunity standard for industrial environments) (Electrostatic discharge immunity test) (Radiated, radio-frequency, electromagnetic field immunity test) (Electrical fast transient/burst immunity test) (Surge immunity test) (Voltage dips, short interruptions and voltage immunity test) (Generic emission standard for industrial environments) (CISPR22 - EMC) (CISPR11 - EMC)</p>		

USER INSTRUCTIONS

- 1) Description:** DIN rail Universal Active Oring Controller for redundant connection to a common Load of 2 DC Power supplies of same rating, with any voltage in the range 12...85Vdc and Load Current ≤ 20A.
Warning: voltages ≥ 60Vdc are dangerous! Use appropriate safety rules!
- 2) Installation:** use DIN-rails according to EN 60715. Installation should be made vertically (see Fig.4). For better device stability fix the rail to the wall close to the point where the device is to be mounted. In order to guarantee sufficient convection, we recommend observing a minimum distance to other modules (see Fig.3).
- 3) Connections:** the device is equipped with pluggable screw terminals. To avoid sparks, do not connect or disconnect the connectors before having previously turned-off input power and waited for internal capacitors discharge (minimum 1 minute)
 In order to comply with UL certification, use appropriate copper cables of indicated cross section, designed for an operating temperatures of:
 60°C for ambient up to 45°C
 75°C for ambient up to 60°C
 90°C for ambient up to 70°C
 Strip the connecting ends of the wires according to the indication and ensure that all strands of a stranded wire enter the terminal connection (see Fig.5)
- 4) Input/Output connection:** The device is suitable for **SELV** and **PELV** circuitry (if you use a source that having Uout higher 60Vdc is not a SELV device)
 Check Uout before connecting the power supply to the load.
- 5) Operating:** at the OR20 is possible connect 2 DC Power supplies in order to obtain a redundancy connection system (see Fig.7), the 2 Power supplies must have setted the same Output voltage rating in order to ensure the corrected redundancy. The correctly current sharing is possible verify through the status LEDs "IN1 OK" and "IN2 OK" (see Fig.1), when you connect 2 DC Power supplies, what is has the higher output voltage determines the voltage threshold and turns on the respective LED, in order to ensure the correct current sharing now you must increase Output voltage of the other Power supply until the two LEDs will not be turned on simultaneously. The precision of redundancy which allows the simultaneous lighting of the two LEDs is about 10% of the highest voltage threshold. When the two LEDs are simultaneously turned on is ensured the redundancy and also the Diagnostic Output "OR OK" relay it is closed.

Fig.1 Connections	Fig.2 Dimensions	Fig.3 Distances															
 <p>(1) Input PS1 20A Max. (2) Input PS2 20A Max. (3) Output Load 20A Max. (4) Diagnostic Output (dry contact, NC output OK) (5) Green LED: IN1 OK (6) Green LED: IN2 OK</p> <p>Input DC Line:</p> <ul style="list-style-type: none"> IN1 + = Positive DC IN1 - = Negative DC IN2 + = Positive DC IN2 - = Negative DC <p>Output DC Line:</p> <ul style="list-style-type: none"> OUT + = Positive DC OUT - = Negative DC 	 <table border="1" data-bbox="691 1232 1042 1420"> <thead> <tr> <th>Dimension</th> <th>mm (inc)</th> </tr> </thead> <tbody> <tr> <td>W</td> <td>35.0 (1.38)</td> </tr> <tr> <td>D</td> <td>104.0 (4.09)</td> </tr> <tr> <td>H</td> <td>103.0 (4.05)</td> </tr> </tbody> </table>	Dimension	mm (inc)	W	35.0 (1.38)	D	104.0 (4.09)	H	103.0 (4.05)	 <table border="1" data-bbox="1042 1232 1498 1420"> <thead> <tr> <th>Distance</th> <th>mm (inc)</th> </tr> </thead> <tbody> <tr> <td>A</td> <td>20 (0.8)</td> </tr> <tr> <td>B</td> <td>20 (0.8)</td> </tr> </tbody> </table>		Distance	mm (inc)	A	20 (0.8)	B	20 (0.8)
Dimension	mm (inc)																
W	35.0 (1.38)																
D	104.0 (4.09)																
H	103.0 (4.05)																
Distance	mm (inc)																
A	20 (0.8)																
B	20 (0.8)																

Fig.4
Mounting / Dismounting Instructions

For DIN rail fastening according to IEC 60715 TH35-7.5(-15)
Mounting as shown in figure, with input terminals on lower side, with suitable cooling and maintaining a proper distance between adjacent devices as specified in the I.S. manual of each family.

Mounting:

1. Tilt the unit slightly backwards.
2. Fit the unit over the top edge of the rail.
3. Slide it downward until it hits the stop.
4. Press against the bottom for locking.

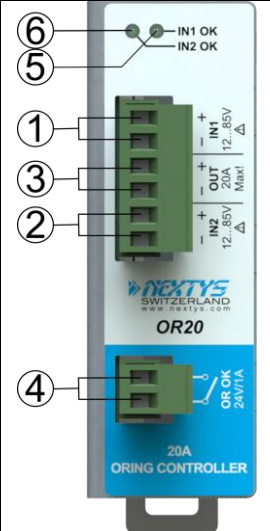
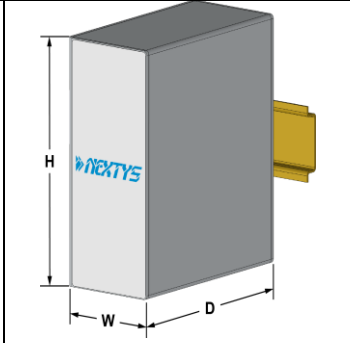
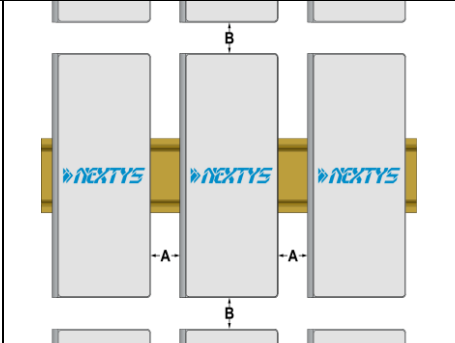
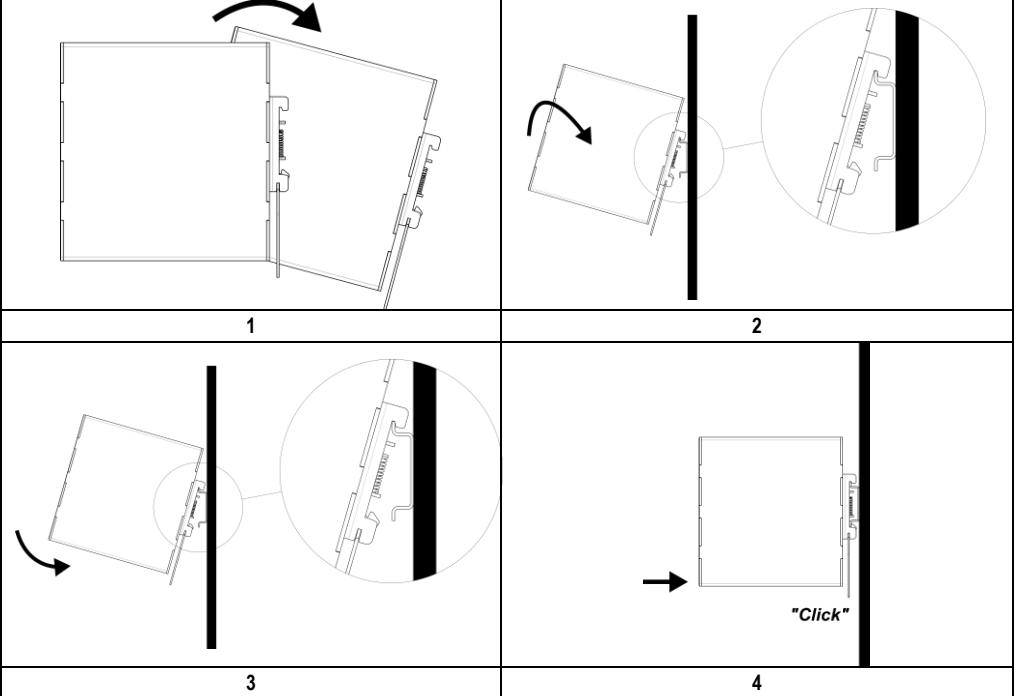

Dismounting:

1. Pull down the slide clamp lever
2. Tilt the unit upward
3. Unhook the unit from the rail

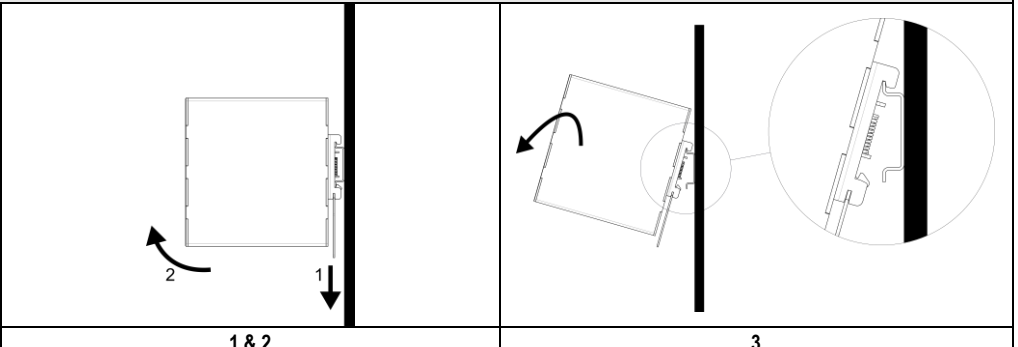

Fig.5
Recommended connecting cable

	<p>Recommended Tightening torque 0.5-0.6Nm 4.42-5.30 lbf in</p>		<p>Solid: 2.5mm² / 12AWG Stranded: 1.5mm² / 12AWG L: 6.0-7.5mm / 0.24-0.30in</p>
---	--	--	--

Fig.6

Input protection

The Device is provided in input against the Reverse polarity connection.

Fig.7

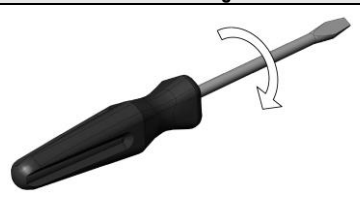
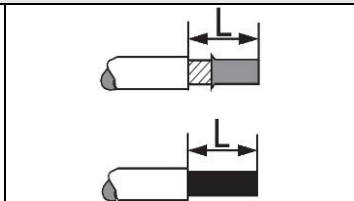
Set-up

Input / output connection

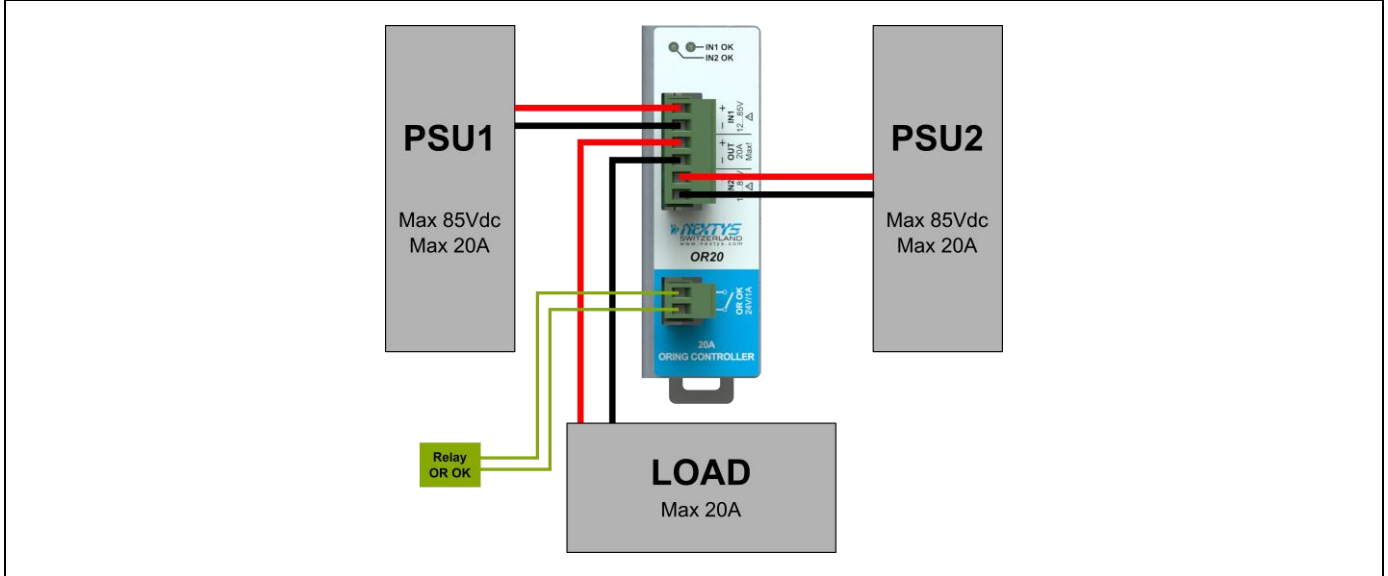

Fig.8

Environment

Operating temperature

- 40°C...70°C
5...95% r.H. non condensing

Derating

No Derating

Note:

- Data may change without prior notice in order to improve the product.
- Please refer to the latest version of the "Instruction Manual" for each product by visiting www.nextys.com

See also the products below that can be used in conjunction with OR20 units:

- This device can be used in conjunction with every each our power supply that is able to provide an regulated Uout included between 12...85Vdc and 20A Max.