

# NPS2400

## 2400W High Efficiency Power Supply

### User's Manual



## **DISCLAIMER**

**NEXTYS** reserves the right to make changes without further notice to any products herein. **NEXTYS** makes no warranty, representation or guarantee regarding the suitability of its products for any particular purpose, nor does **NEXTYS** assume any liability arising out of the application or use of any product, and specifically disclaims any and all liability, including without limitation consequential or incidental damages. "Typical" parameters which may be provided in **NEXTYS** data sheets and/or specifications can and do vary in different applications and actual performance may vary overtime. All operating parameters, including "Typicals", must be validated for each customer application by customer's technical experts. **NEXTYS** does not convey any license under its patent rights nor the rights of others. **NEXTYS** products are not designed, intended, or authorized for use as components in systems intended for surgical implant into the body, or other applications intended to support or sustain life, or for any other application in which the failure of the **NEXTYS** product could create a situation where personal injury or death may occur. Should Buyer purchase or use **NEXTYS** products for any such unintended or unauthorized application, Buyer shall indemnify and hold **NEXTYS** and its officers, employees, subsidiaries, affiliates, and distributors harmless against all claims, costs, damages, and expenses, and reasonable attorney fees arising out of, directly or indirectly, any claim of personal injury or death associated with such unintended or unauthorized use, even if such claim alleges that **NEXTYS** was negligent regarding the design or manufacture of the part.

The Customer should ensure that it has the most up to date version of the document by contacting its local **NEXTYS** office. This document supersedes any earlier documentation relating to the products referred to herein. The information contained in this document is current at the date of publication. It may subsequently be updated, revised or withdrawn.

The Customer should ensure that **NEXTYS** product uses the most up to date Software and Firmware provided on **NEXTYS** website to ensure reliable operation of the system.

**NEXTYS** assumes no responsibility for improper use or use not listed in the following document.

All Trade Marks recognized. Specifications and information herein are Subject to change without notice.

## TABLE OF CONTENTS

1	Acronyms.....	3
2	Introduction.....	4
3	Functional description.....	6
4	Installing the NPS2400.....	7
4.1	General considerations.....	7
4.2	Mounting and dismantling the device.....	8
4.3	Connecting the device.....	9
4.4	Maintenance.....	17
5	Operating modes.....	17
5.1	Overboost mode (default).....	17
5.2	Constant current limit mode.....	18
5.3	Battery charger mode (available only on “-24”, “-48” and “-72” models).....	19
6	User interface.....	22
6.1	Principles of operation.....	22
6.2	Contrast adjustment.....	23
6.3	Initial and standard screens.....	23
6.4	Set-up menu.....	25
6.5	Measurements.....	31
6.6	Event log.....	32
6.7	Information.....	37

## 1 Acronyms

<i>Acronym</i>	<i>Definition</i>
SMPS	Switching Mode Power Supply.
COMM BOX	NPS2400 Communication board. Used to interface a PC to the SMPS.
PFC	Power Factor Corrector
PE	Protective Earth
SELV	Safety Extra Low Voltage
PELV	Protective Extra Low Voltage
FW	Firmware

## 2 Introduction

**⚠ Use latest device Documentation, Software and Firmware to ensure reliable operation of the system (downloadable from [www.nextys.com](http://www.nextys.com)).**

The NPS2400x series is a high power, high performance, CPU controlled 3-phase input SMPS family. These products present many advanced features such as:

- Very high efficiency (>92%)
- Compactness
- PFC input
- Operating also with DC input
- Wide range of output voltage
- Integrated active ORing circuit for all models
- Increased input protection against various mains abnormalities (overvoltage, surge, micro-interruptions, etc.)
- Remote shutdown
- Voltage sense function
- 4-20 mA and 0-10 V output current remote measurement
- User programmable auxiliary dry contact
- Load share (up to 4 units can be paralleled for redundancy or power increase)
- 3 operating modes:
  - Overboost which can deliver up to 150% of the rated current for a maximum of 5 seconds
  - Constant current
  - Lead-acid, LiFePO4 and NiCd/NiMH battery charger (only on “-24”, “-48” and “-72” models) with temperature compensation for lead acid only
- Microcontroller based for:
  - Monitoring
  - Operating control and supervision
- User interface
  - Embedded user interface (4 user buttons, 2 LEDs and 1 LCD display):
    - Displays real time status and alarms
    - History of events, time stamped (a Real Time Clock is implemented)
  - PC application through USB interface (using included COMM BOX interface):
    - Remote configuration of the device
    - Firmware upgrade
    - Same functionalities of the embedded user interface with the ease of the PC benefits

The NPS2400x family includes 4 models with 4 different output voltages and current ratings for a rated power of 2400 W (peak overload power of 3600 W).

<i>Model name</i>	<i>Rated Vout [VDC]</i>	<i>Vout min [VDC]</i>	<i>Vout max [VDC]</i>	<i>Rated Iout /Ipeak[A]</i>	<i>Rated /peak power [W]</i>
NPS2400-24	24	11.5	29	100 / 150	2400 / 3600
NPS2400-48	48	23	56	50 / 75	2400 / 3600
NPS2400-72	72	50	87	33 / 50	2400 / 3600
NPS2400-170	170	85	175	14 / 21	2400 / 3600

**Table 1 : Models ratings**

Figure 1 shows a front view of the SMPS with a short description of the main elements.

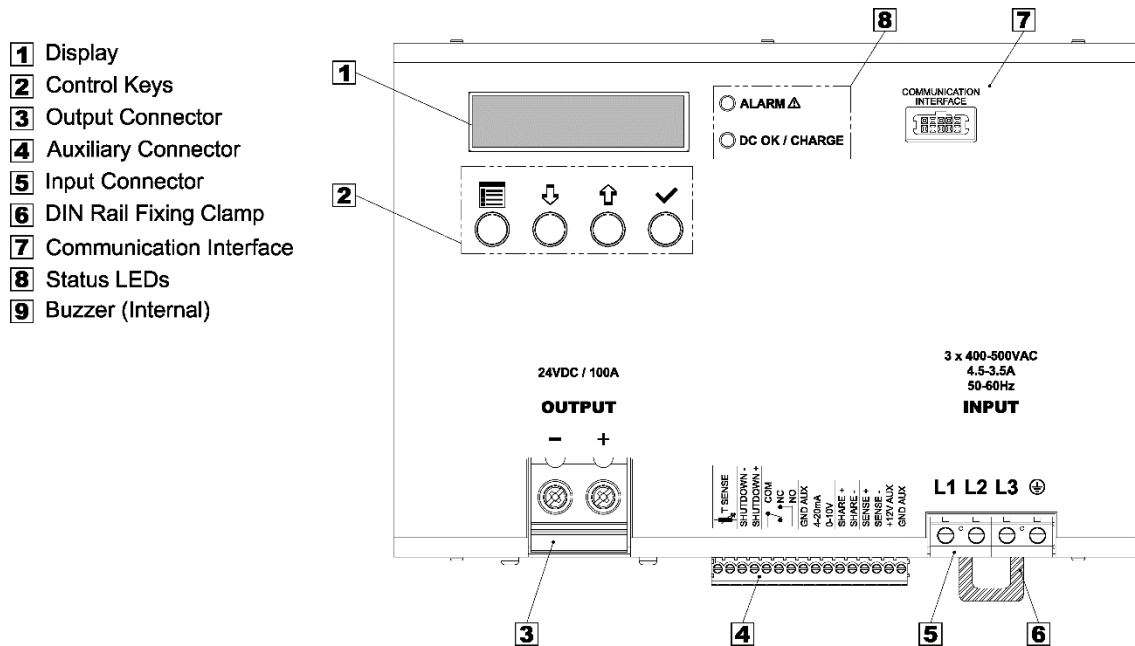

Figure 1 : NPS2400 front view

Figure 2 shows the auxiliary connector I/Os.

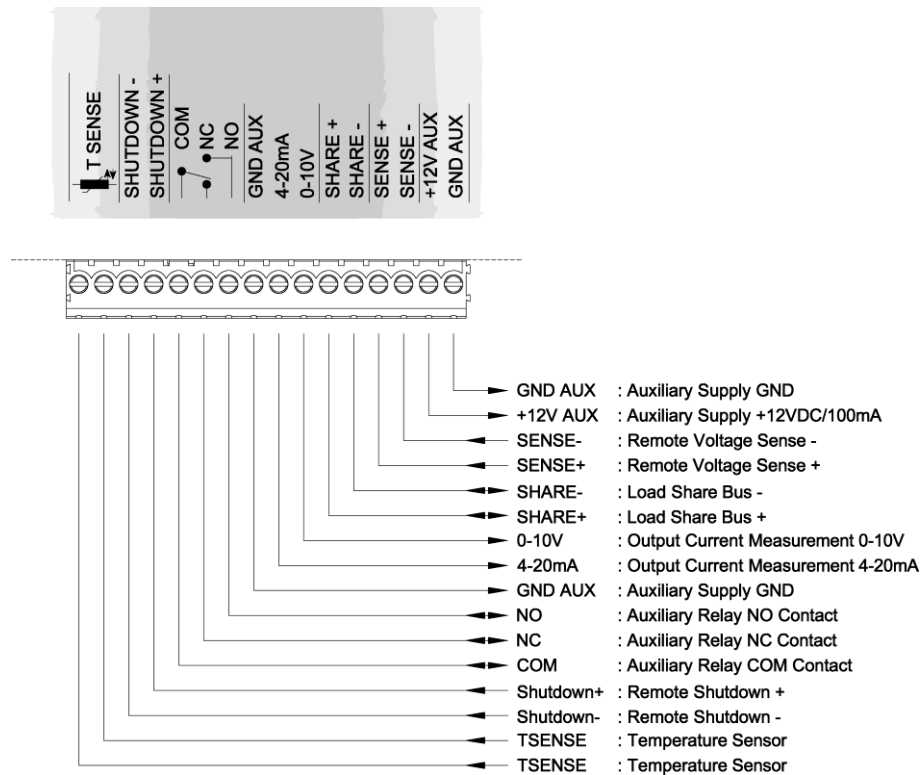

Figure 2 : Auxiliary connector I/Os

### 3 Functional description

A simplified block diagram of the NPS2400 is shown in Figure 3.

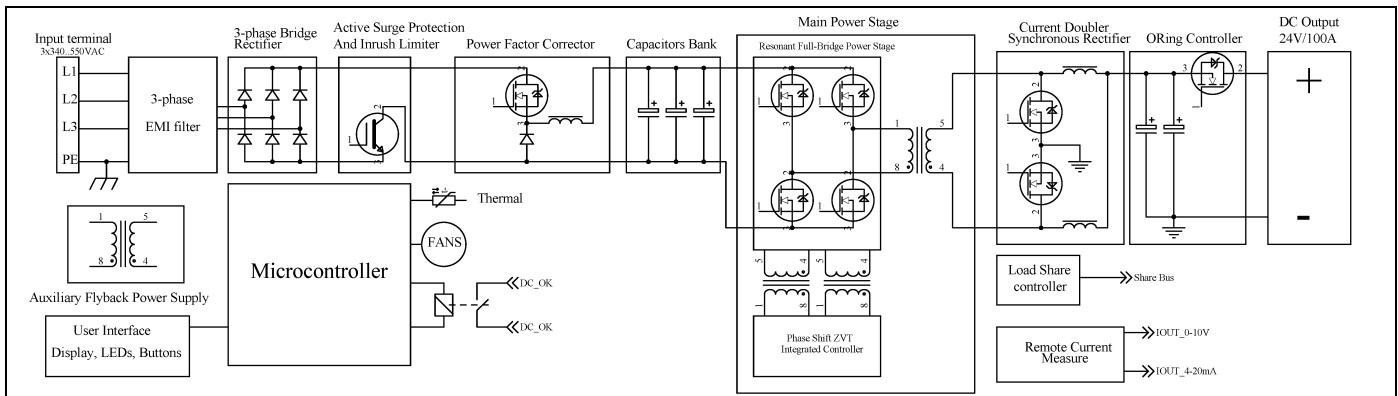

Figure 3 : NPS2400 simplified block diagram

NPS2400 is a 3-phase input SMPS with 2 power stages, supervised by a microcontroller. The first stage is a power factor corrector (PFC) module that improves unit efficiency and reduces the harmonic current from the mains. The second stage is a resonant full bridge converter that provides primary to secondary insulation and high efficiency power conversion. The product offers additional features that improve the performances and the reliability:

**Integrated active ORing diode:** allows connecting several devices in parallel for redundancy (see §4.3.4). When several units are paralleled for increase of the total output power (up to 8.7kW) this circuit increases the reliability of the system in case of 1 unit failure.

**Load share functionality:** allows connecting up to 4 devices in parallel to increase the output power up to 8.7kW. A dedicated bus allows to equally share the total load current between the paralleled devices.

**Remote voltage sensing:** allows regulating the output voltage directly at the load terminals compensating the cables and connectors voltage drop when long cables are used.

**Active surge protection:** this circuit increases the reliability by protecting the device from high voltage transients occasionally present on the 3 phase mains. On top of that this circuit performs also the function of active inrush current limiter reducing the inrush current to very low values.

**Smart thermal management:** the fans' speed is controlled according to load and internal temperature conditions. This allows maintaining a safe temperature of the critical parts while maximizing the fans operating life and minimizing the fans noise.

**Remote output current measure:** the user can measure remotely the output current delivered by the SMPS. The information is provided through an opto-isolated output with 2 industry standard ranges: 0...10V or 4...20mA for 0A to rated output current.

**Remote shutdown input:** it allows to remotely switch the SMPS ON or OFF without cutting the 3 phase mains. An opto-isolated input can be configured as a remote shutdown/enable input

**Auxiliary 12V output:** the units provide a regulated 12V/0.1A output completely insulated from the main output. It can be used to supply light 12V loads, independently on the SMPS output voltage/status.

**Battery charger mode (only on “-24”, “-48” and “-72” models):** this operating mode allows operating the device as a high performance battery charger for lead-acid, lithium iron phosphate (LiFePo4) and NiCd/NiMH batteries. 12V, 24V, 48V, 60V and 72V batteries can be charged up to a capacity of 1000Ah. Refer to Table 3 for the maximum battery capacity based on chemistry. The lead acid and nickel batteries share the same capacities.

## 4 Installing the NPS2400

### 4.1 General considerations

**⚠ Warning:** NPS2400 is a high voltage and high current SMPS. In order to avoid potentially hazardous situations including fire hazard, safety recommendations must be followed. Only authorized staff can install the unit.

#### 4.1.1 Input voltage

**Vin= 3x400...500VAC** (range=340...550VAC) or **520...750VDC**. Use with only 2 phases connection is prohibited. Under **emergency conditions only** the units can operate with 2 phases input with reduced maximum power to ½ of the nominal. Connect the Earth (PE) wire before connecting L1/L2/L3 wires and keep it as short as possible. The wire gauge should be at least 1.5 mm<sup>2</sup> (15 AWG).

#### 4.1.2 Input protection devices

NPS2400 is **NOT** equipped with an internal protection fuse. Use external breaking and protection devices as circuit breakers rated 10A and characteristic C, properly rated for the operating voltage and with a minimum breaking power of 1.5kA. **Over-Current protection must be provided on each phase.**

For USA and Canada use fuses class CC rated 10A. In some countries local regulation may apply.

Special ratings and devices should be used for DC input applications. **Call factory for information.**

**Surge protection:** it is strongly recommended to provide external surge arresters according to local regulations.

#### 4.1.3 Input connector wiring

The input mains terminal block accepts wires up to 4mm<sup>2</sup> (11AWG). Strip the wire insulation for 8mm, screw tightening torque 0.5...0.6Nm, use only 60/75 Class 1 copper wires.

**⚠ Warning:** before operating on the device disconnect the AC mains and wait at least 1 minute.

#### 4.1.4 Output connector wiring

The output terminal block accepts wires up to 35mm<sup>2</sup> (2AWG). Strip the wire insulation for 15mm, screw tightening torque 2.5...4.5Nm, use only 60/75 Class 1 copper wires. Refer to Table 2 to define the minimum wire gauge for each model.

Model name	Rated Vout [VDC]	Rated Iout [A]	Minimum wire gauge [mm <sup>2</sup> /AWG]
NPS2400-24	24	100	25 / 3
NPS2400-48	48	50	10 / 7
NPS2400-72	72	33	6 / 9
NPS2400-170	170	14	2.5 / 13

**Table 2 : Recommended output wire gauge**

#### 4.1.5 Auxiliary connector wiring

The auxiliary terminal block accepts wires from 0.5mm<sup>2</sup> (20AWG) to 1.5mm<sup>2</sup> (15AWG). Strip the wire insulation for 5mm, screw tightening 0.25Nm, use only 60/75 Class 1 copper wires.

#### 4.1.6 Feeding DC motors

It is possible to feed DC motors considering that when a motor starts-up under effort its consumption is much higher than the nominal current and it can trigger overcurrent protection. For these applications, the Constant Current mode of current limitation is recommended.

**⚠ Warning:** motors can generate high conducted noise on the DC line and potentially harmful reverse surges.

It is strongly discouraged to supply motors on the same DC line. Use their own properly configured motor drivers together with own braking devices such as resistors, clamps or any other specific device.

#### 4.1.7 Cooling

Mount the device in vertical position, keep at least 80mm (3inch) free spacing on upper and lower side, 10mm (0.4inch) free spacing between adjacent devices. Check periodically that the air inlets in the enclosure are free from dust and other debris that can obstruct the air flow.

Mount the device in the cooler zone of the cabinet. The thermal protection is activated if the surrounding air temperature is >50°C (122 °F) along with continuous full load operation. The device restarts automatically after cooling down.

## 4.2 Mounting and dismounting the device

### 4.2.1 Mounting the device

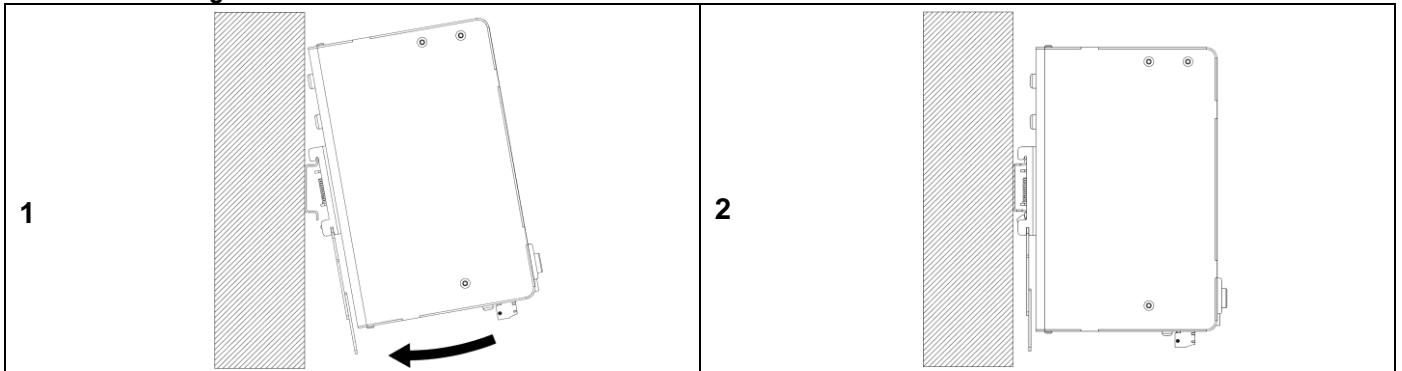

**Figure 4 : Mounting the device on DIN rail**

Snap on the device on IEC60715/H35-7.5 rail; push the bottom side of the device towards the rail. The device will be automatically locked to the rail.

### 4.2.2 Dismounting the device

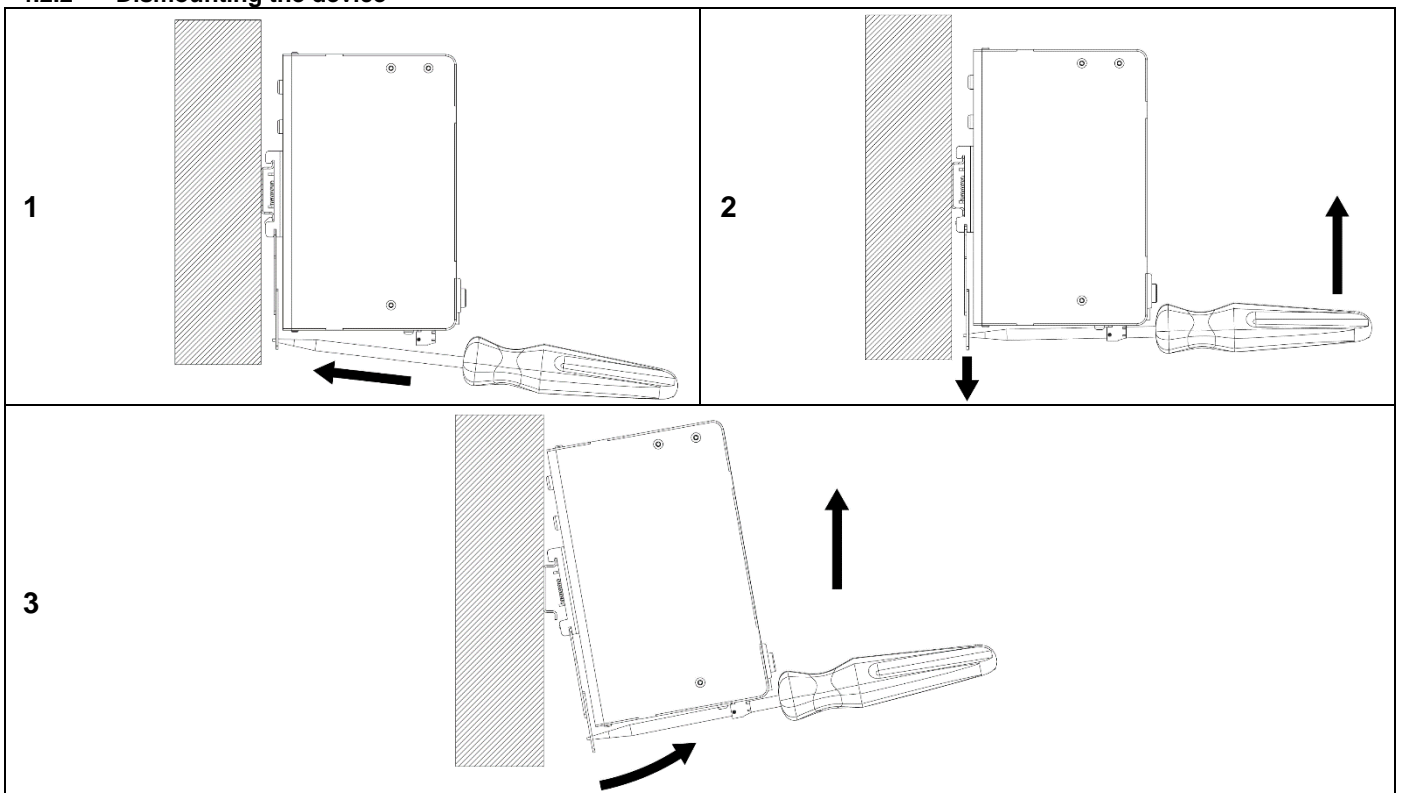

**Figure 5 : Dismounting the device on DIN rail**

Pull down the slide using a screwdriver and then free the bottom part by rotating the device upwards.



## 4.3 Connecting the device

### 4.3.1 Standard connection

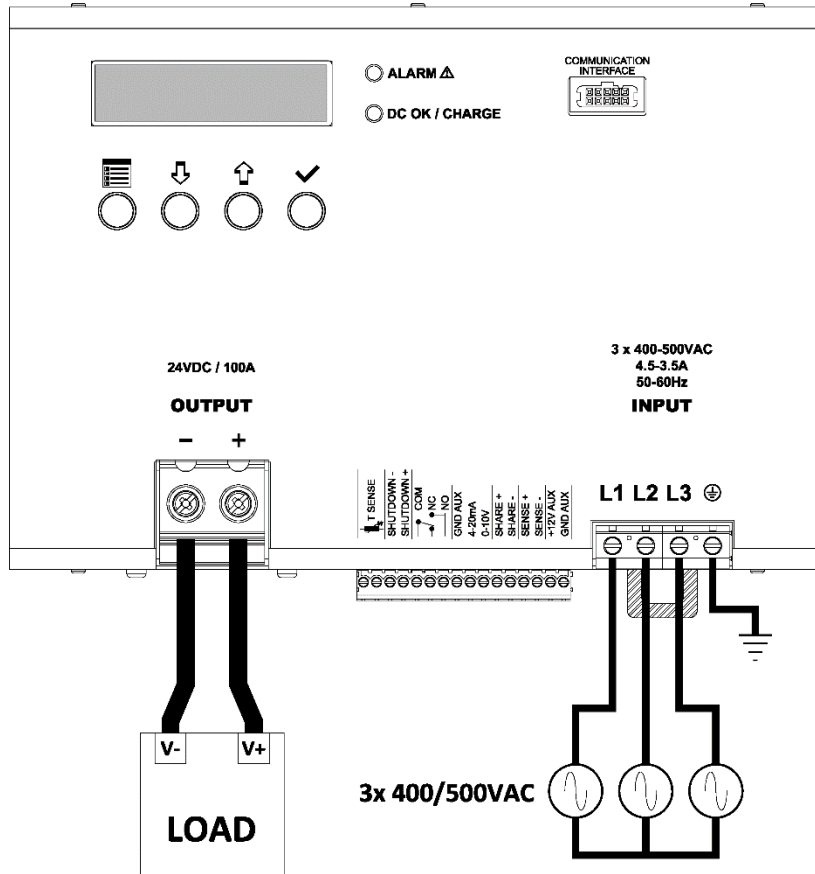

Figure 6 : Standard AC device connection

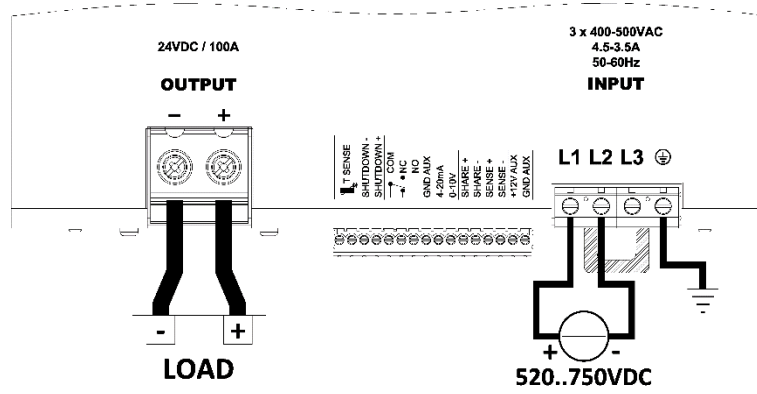
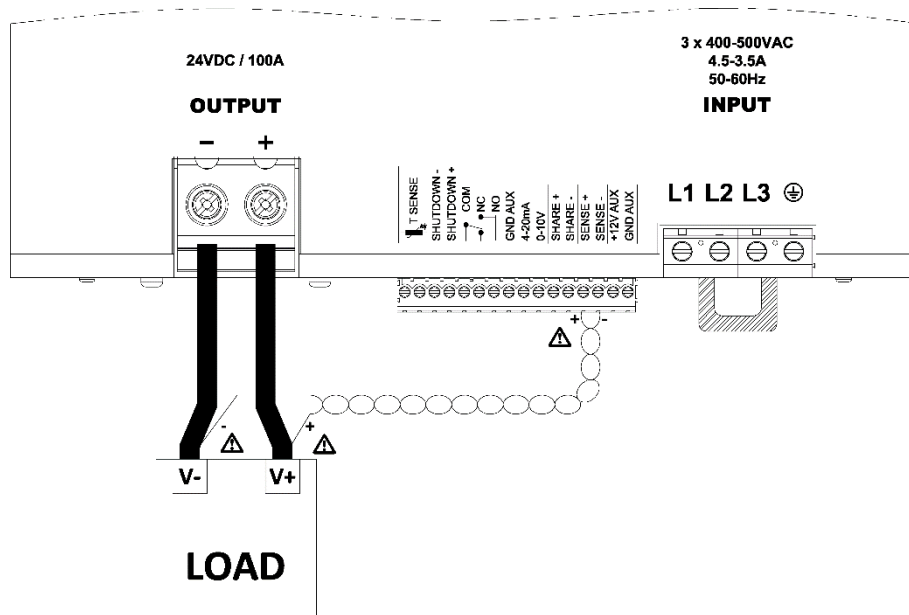

Figure 7 : Standard DC device connection

This is the basic configuration: connect the mains and the load using wires of appropriate gauge as stated in §4.1.

**⚠** Check the polarity of the output load before applying mains.

#### 4.3.2 Connection with remote voltage sense



**Figure 8 : Connection using remote voltage sense**

When the load is placed far away from the SMPS or when tight voltage accuracy is needed by the load, the NPS2400 provides a feature to compensate the output cables I\*R voltage drop. Once the set-up is configured as shown above power on the load, measuring the voltage directly at the load using a multimeter. Adjust the output voltage through the LCD screen and the Control Keys or Powermaster until the desired voltage is reached at the load terminals. It can tightly regulate the output voltage directly at the load terminals and not at the SMPS output terminal, within 10mV of precision.

For applying this feature 2 additional cables (any flex wire from 0.5mm<sup>2</sup>/20 AWG to 1.5mm<sup>2</sup>/15 AWG) are connected from the load terminals to the SMPS auxiliary connector SENSE+ and SENSE- terminals.

It is strongly recommended to **twist the 2 wires** together in order to improve the noise and interference immunity.

**⚠ Please check and respect the polarity of the sense wires! If the polarity is reversed the SMPS output voltage of the SMPS will increase to its maximum. Although not harmful for the SMPS itself (an output overvoltage error will be triggered) this condition can damage the load.**

**Note 1:** The voltage displayed on the LCD screen is always the voltage at the SMPS output and not the voltage at the load terminals.

**Note 2:** In case of very long output cables with consistent I\*R cable drop the device could no more be able to deliver the rated output current. The rated output power is however maintained.

**Note 3:** In case of very long output cables with a consistent I\*R cable drop, the device may no longer be able to supply the desired voltage. Since the maximum voltages that can be supplied by the devices are according to **Table 1 : Models ratings**.

**Example:**  $V_{load}=24V$ , cable drop=0.5 V (per cable), voltage at SMPS output= $24V+2*0.5V=25V$  Maximum output current= $2400W/25 V=96A$  (not 100A!).

### 4.3.3 Connection in series

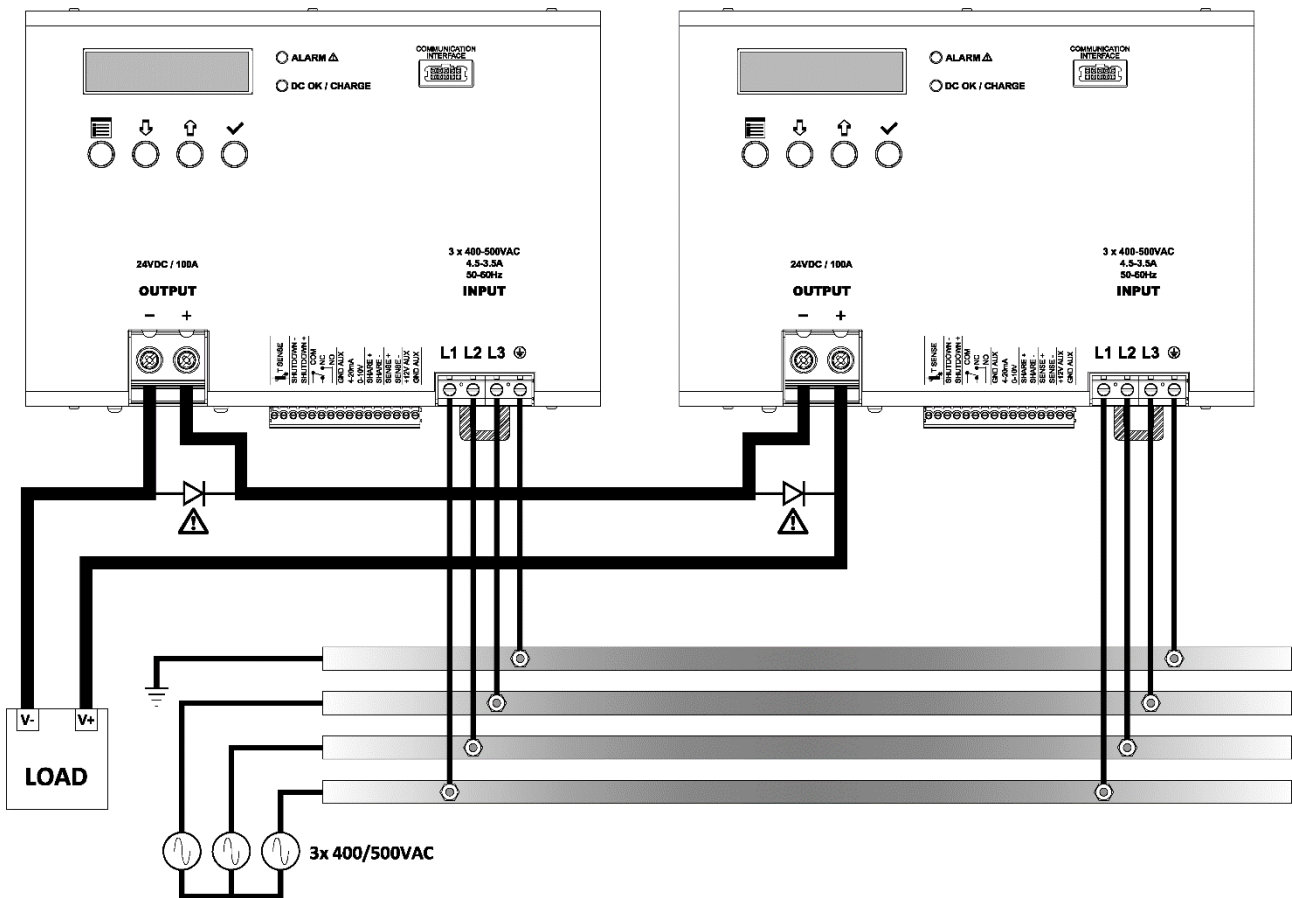



Figure 9 : Connection of multiple units in series

The series connection allows increasing the total output voltage. Connect the output terminals of each device in series checking the right polarity.

- Note 1:** Before any power ON be sure to have connected the **antiparallel diodes** to all units. The voltage rating of EACH diode should cover the TOTAL voltage of the SERIES system. A diode as P600J is suitable for most applications.
- Note 2:** Only SMPS of the same model (**same rated output voltage**) can be connected in series. **Do not exceed > 4 units connected in series and > 200Vdc total voltage. For other situations contact the factory.**
- Note 3:** To achieve the best power sharing between the series connected devices it is recommended to regulate the output voltage of each device at the same value with a tolerance of maximum 0.1V.
- Note 4:** When using several devices in series the operating mode must be set to OVERBOOST, using CONSTANT CURRENT mode can result in instabilities in case of load short circuit. The maximum current setpoint shall be the same on every connected device.

-  **When the units are used in series do not connect anything to the auxiliary connector SENSE+/SENSE- and SHARE+/SHARE-. Any connection to these signals may damage the units and the connected load.**
-  **Don't use the Battery Charger operating mode when more units are connected in series**

#### 4.3.4 Connection in parallel (power and redundancy)

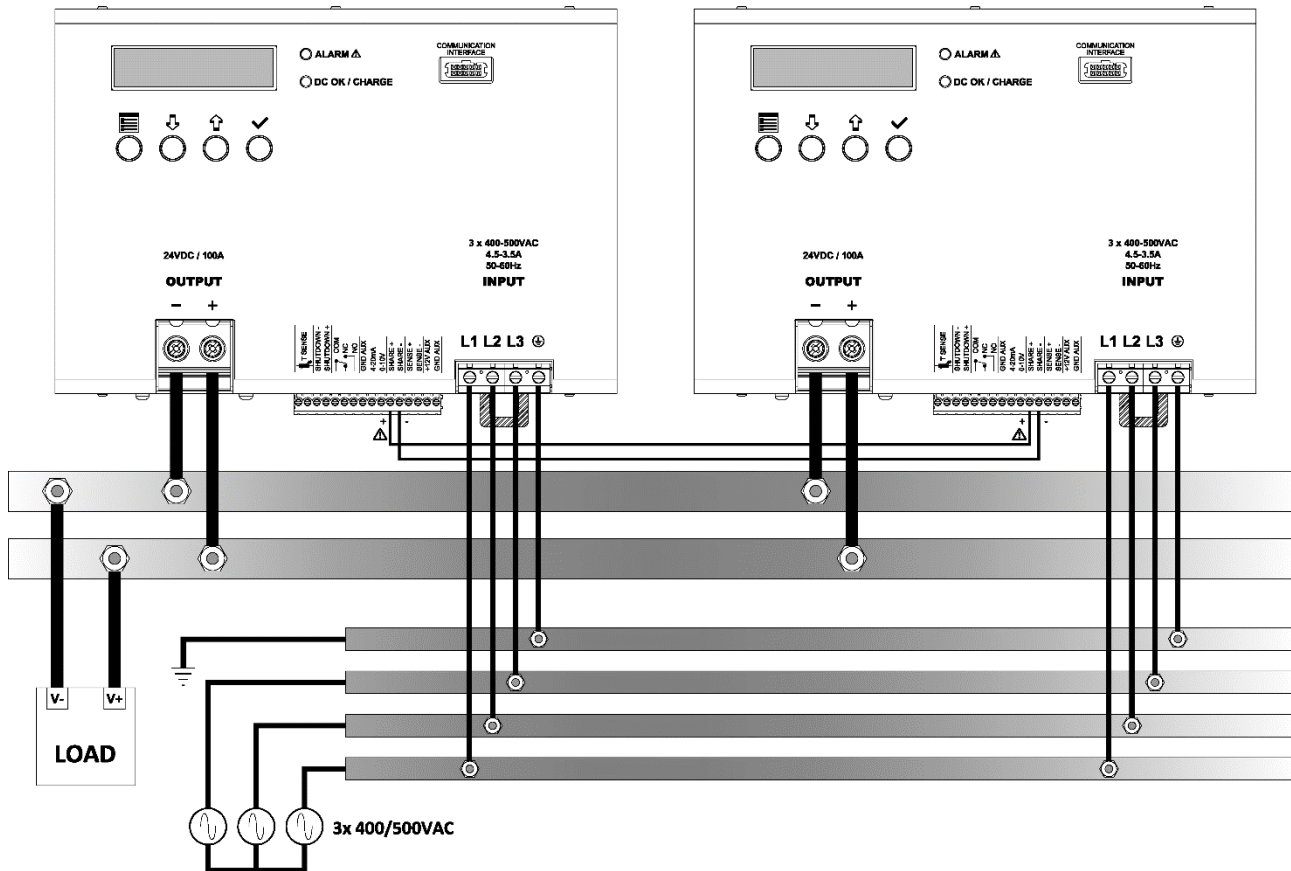

Figure 10 : Connection of multiple units in parallel





The parallel connection may have **one** of the following purposes:

- 1) **Redundancy:** several units (unlimited number in theory, 2..4 units in practice) can be used to increase the system reliability. If one SMPS fails the load will be still powered from another SMPS connected in parallel. The NPS2400 integrates an active ORing diode so that several units can be directly connected in parallel without the need for an external ORing module. In this configuration the **maximum power sunk by the load must be < P<sub>nom</sub>**. The **SHARE+/SHARE-** signals should **NOT** be connected.
- 2) **Power increase:** this configuration is used to increase the system power capacity by summing the output current of each individual SMPS connected in parallel to the load. To obtain the system's best performance SHARE+/SHARE- signals must be daisy chain connected on all SMPS'. This allows equal current sharing between all the SMPS'.

**Note 1:** When used in parallel for power increase the maximum number of SMPS is 4 units.

**Note 2:** When used in parallel for power increase the maximum total output current will be  $0.9 \cdot I_{out} \cdot N$ , where N is the number of connected SMPS'. The **maximum power** is thus limited to  $0.9 \cdot N \cdot P_{nom} < 8.7 \text{ kW}$ .

**Note 3:** To achieve the best power sharing between the parallel connected devices the output voltage of each device must be adjusted at the same value with a tolerance of maximum 0.2V. The share bus will then slightly vary the output voltage of each SMPS to achieve the best possible power sharing.

-  **When more units are operated in parallel they shall be set to "constant current limit (CC)" mode; Overboost and battery charger operations are not allowed.**
-  **Do not connect anything to the auxiliary connector SENSE+/SENSE- when using the SHARE+/SHARE- connection! Wrong connection to these signals may damage the devices and the connected load.**
-  **Don't use the Battery Charger operating mode when more units are connected in parallel.**
-  **Respect the polarity of the SHARE+/SHARE- connections!**

#### 4.3.5 Battery charger connection (only on “-24”, “-48” and “-72” models)

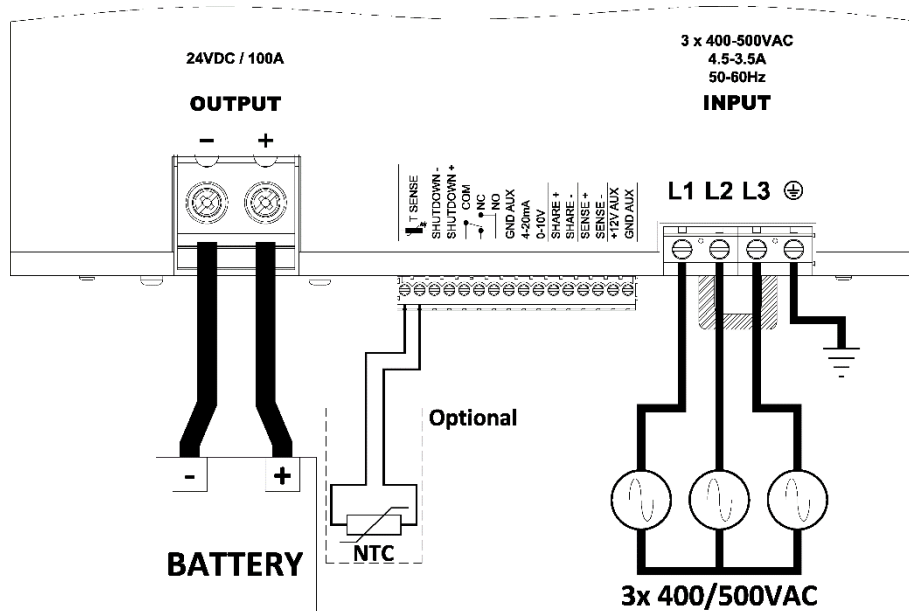





Figure 11 : Connection when used as battery charger

The “-24”, “-48” and “-72” models feature a function of battery charger, “-24” model can charge 12V and 24V batteries with capacity from 50Ah up to 1000Ah, “-48” model can charge 48 V batteries only with capacity ranging from 25Ah up to 500Ah while “-72” model from 15Ah up to 300Ah. Refer to Table 3 for the maximum battery capacity based on chemistry. The lead acid and nickel batteries share the same maximum capacities.

The device has an input for an *optional* 10kΩ NTC (Murata NPSD0XH103FEB0 or equivalent) used to sense the battery ambient temperature.

When using the temperature sensor the battery can be recharged in a more accurate way since the device regulates its charging voltage according to the battery ambient temperature.

-  **This device is not a UPS nor has to be used in any kind of backup. Operating the device as a backup system can damage the unit and/or create unexpected behaviours.**
-  **Respect the battery polarity! The device is NOT protected against battery polarity reversal. A connection with wrong battery polarity will damage the device and generate a fire hazard.**
-  **Battery charger function can be used ONLY in combination with battery. No loads are allowed to be connected to the battery terminals. Operation of the battery charger function can be disturbed.**
-  **Use of battery charger function is not allowed when more units are connected in series or in parallel.**

### 4.3.6 Output current remote measurement

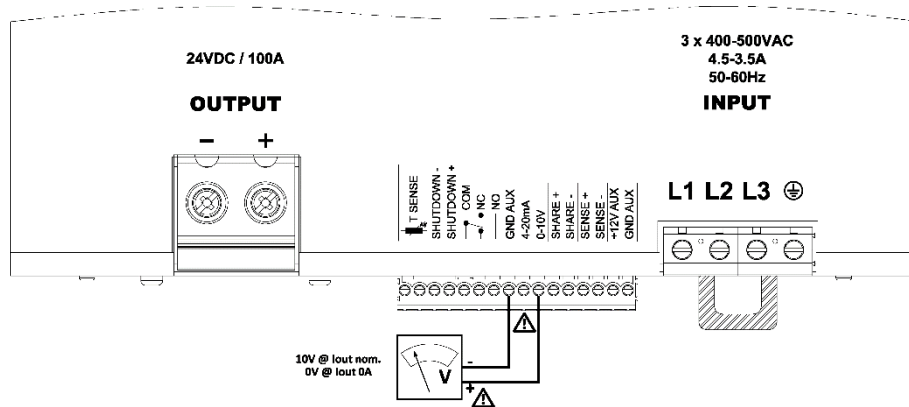

Figure 12 : 0...10V output for SMPS output current remote measure connection

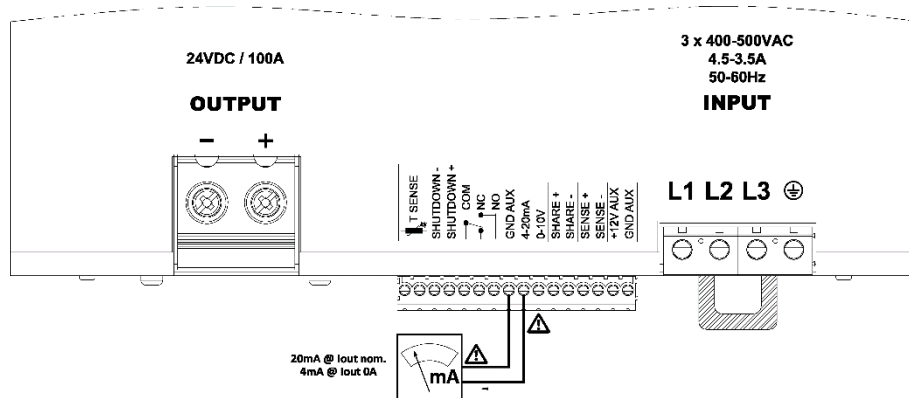

Figure 13 : 4...20mA output for SMPS output current remote measure connection

The NPS2400 provides 2 different outputs for the remote measurement of the current delivered by the device. The 2 outputs follow 2 major industry standards levels:

**0...10V voltage output:** 0V corresponds to 0A output, 10V corresponds to the rated output current of the SMPS

**4...20mA current output:** 4mA corresponds to 0A output, 20mA corresponds to the rated output current of the SMPS

**Note:** The 2 outputs are floating with respect to the SMPS output (opto-isolated), but their ground is common to GND AUX. Take care of ground loops when using the remote current measurement in conjunction with the 12 V auxiliary output.



Respect the connection polarity!

#### 4.3.7 Remote shutdown input

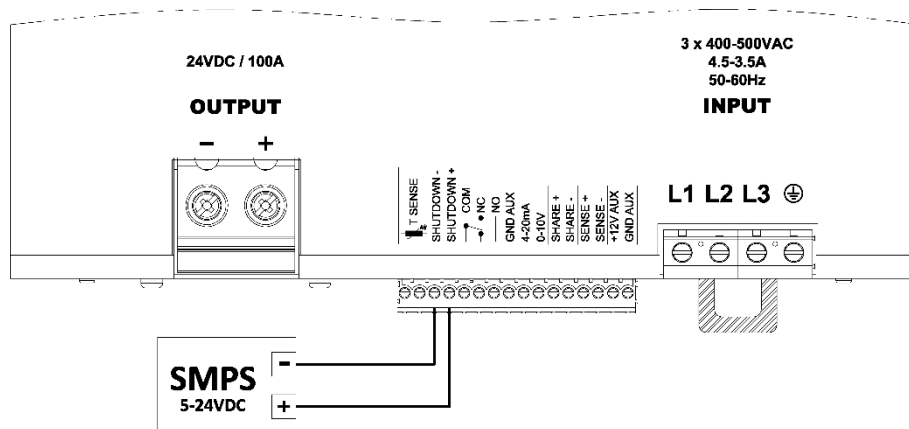

Figure 14 : Remote shutdown input connection with external signal

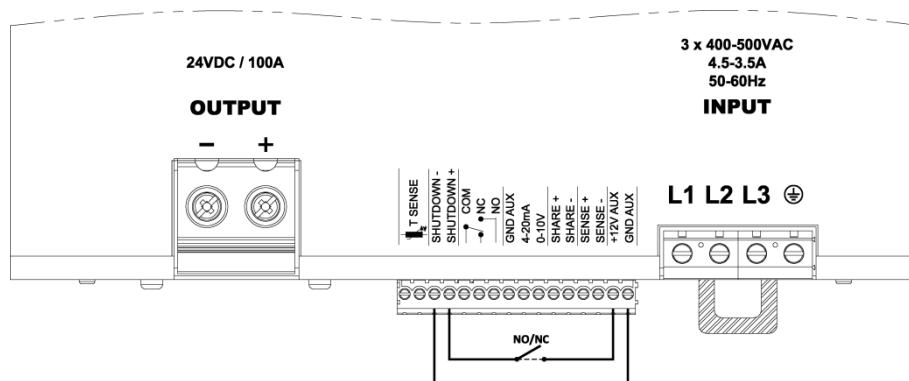

Figure 15 : Remote shutdown input connection by using the AUX power supply

The device includes an opto-isolated input used to remotely shutdown or enabling the device output without the need for disconnecting the mains input. This input can be used in 2 ways:

- External signal:** when applying an external DC voltage as shown on Figure 14 from 5VDC to 24VDC to the SHUTDOWN inputs the NPS2400 output will be turned ON or OFF depending on the programmed shutdown polarity (see §6.4.9).
- External switch or relay contact:** by connecting an external switch or relay contact as indicated in Figure 15 the NPS2400 output can be switched ON or OFF by only acting on the switch or relay contact.

#### 4.3.8 Auxiliary 12V/100mA output

The NPS2400 provides an **auxiliary power supply rated 12V/100mA** (max.). This supply is available on the **+12V AUX/ GND AUX** terminals of the auxiliary connector. The auxiliary supply is floating (isolated) with respect to the SMPS output. Take care when using the 12V auxiliary output in conjunction with remote output current measurement to avoid ground loops. The 12V auxiliary output is short circuit protected by an active circuit.

#### 4.3.9 Auxiliary relay dry contacts

NPS2400 provides an SPDT relay with normally open (NO) and normally closed (NC) dry contacts. They normally indicate that the output voltage is present and regulated (DCOK). Other functions are available for the relay, see chapter 6.4.19, 6.4.20, 6.4.21 and 6.4.22 for details. When the device is operating in battery charger mode (only on “-24”, “-48” and “-72” models) the relay is excited when the battery charging process is terminated, overriding all the other functions.

 **Pay attention, please respect the relay ratings: 24Vdc/1A**

4.3.10 Connection to a PC through the USB communication box COMM BOX

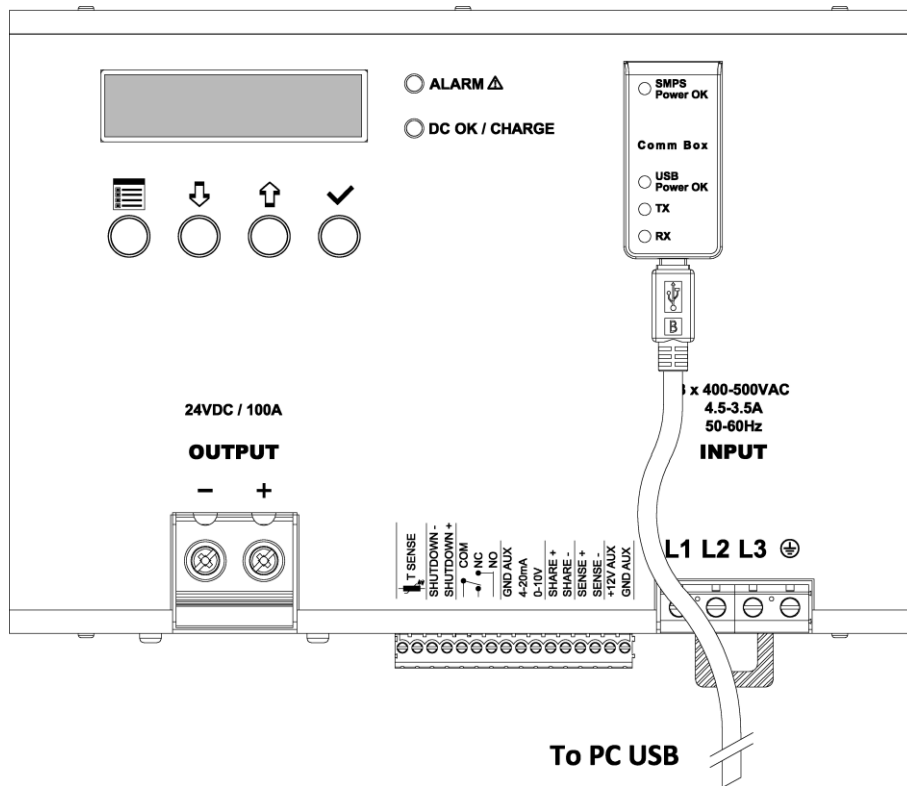

Figure 16 : Connection of the USB communication box

The NPS2400 is provided with a connector called *communication interface* where the **USB communication box COMM BOX** must be connected. This allows interacting with the device using a PC provided with USB interface and a specific PC application ("POWER MASTER").



## 4.4 Maintenance

The FAN should be checked periodically (recommended: every 6 months). Dirty fans can be cleaned using compressed air generated by a vacuum cleaner from outside of the unit. Do not use high pressure air flux, it can damage the unit. Optionally a *maintenance reminder* can be activated by factory (see §6.6.20). The reminder will be activated after a user definable hours of operation. To acknowledge the reminder the user must keep the button up and the button down pressed for more then 3 second.

## 5 Operating modes

NPS2400 power supply has 3 different operating modes, user selectable (see §6.4.13).

- *Overboost (OB)*
- *Constant current limit (CC)*
- *Battery charger (BC-* available only on “-24”, “-48” and “-72” models)

### 5.1 Overboost mode (default)

NPS2400 in *Overboost mode* can provide a temporary power boost up to 150% (3600W) of its rated power for a maximum of 5 seconds. This mode is suitable for powering loads with high inrush current such as motors or highly capacitive loads. It also helps in blowing fuses of failed loads and separate those from other active loads connected in parallel. The output U/I behaviour in *OB* mode is presented in Figure 17.

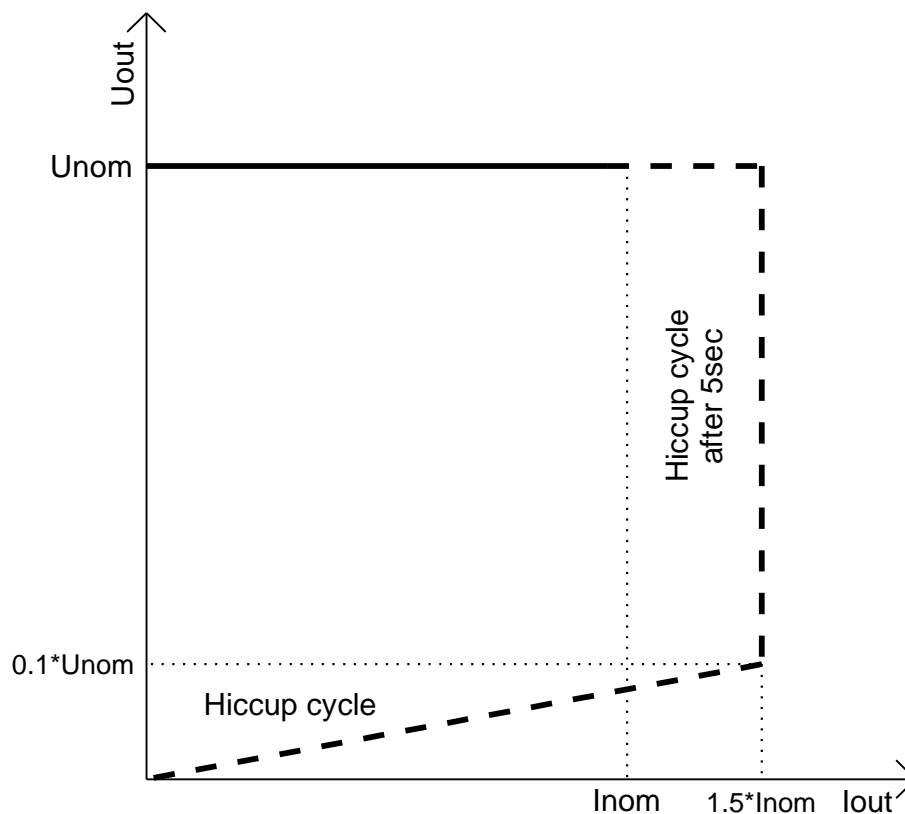

Figure 17 : Output voltage vs. current characteristics in Overboost mode

As soon as the output current becomes  $> I_{nom}$  a timer is started; when the timer elapses (5 s) the output is shut OFF and kept OFF for 10 seconds (hiccup cycle – 5 s ON/10 s OFF). In case of a “dead short circuit” on the output ( $U_{out} < 0.1 \cdot U_{nom}$ ) the maximum current is still limited at  $1.5 \cdot I_{nom}$ , but the output shuts off after about 100 ms entering a hiccup cycle.

## 5.2 Constant current limit mode

When operating in *constant current limit mode* NPS2400 behaves as a *constant voltage source* or *constant current source* depending on the load. CC mode is suitable for powering loads that do not need high peak currents. The output maximum current can be set between  $0.1 \cdot I_{nom}$  and  $I_{nom}$  (see §6.4.5). It will never exceed the programmed value independently on the load behavior.

In case of a “dead short circuit” on the output ( $U_{out} < 0.1 \cdot U_{nom}$ )  $I_{max}$  is still limited at  $I_{nom}$ , but the output shuts OFF after about 100 ms, entering a hiccup cycle.

This mode can be suitable also for powering systems that have a back-up battery in parallel to the load. The output U/I behavior in CC mode is presented in Figure 18.

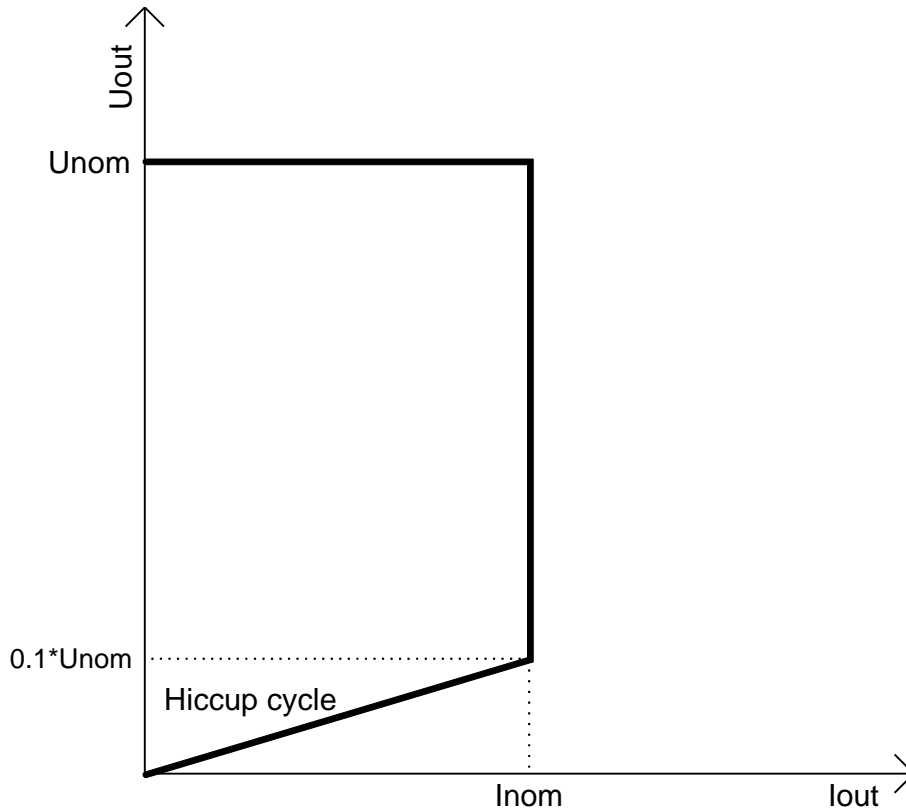

Figure 18 : Output voltage vs. current characteristics in constant current limit mode

## 5.3 Battery charger mode (available only on “-24”, “-48” and “-72” models)

### 5.3.1 Lead acid and lithium iron phosphate (LiFePO4)

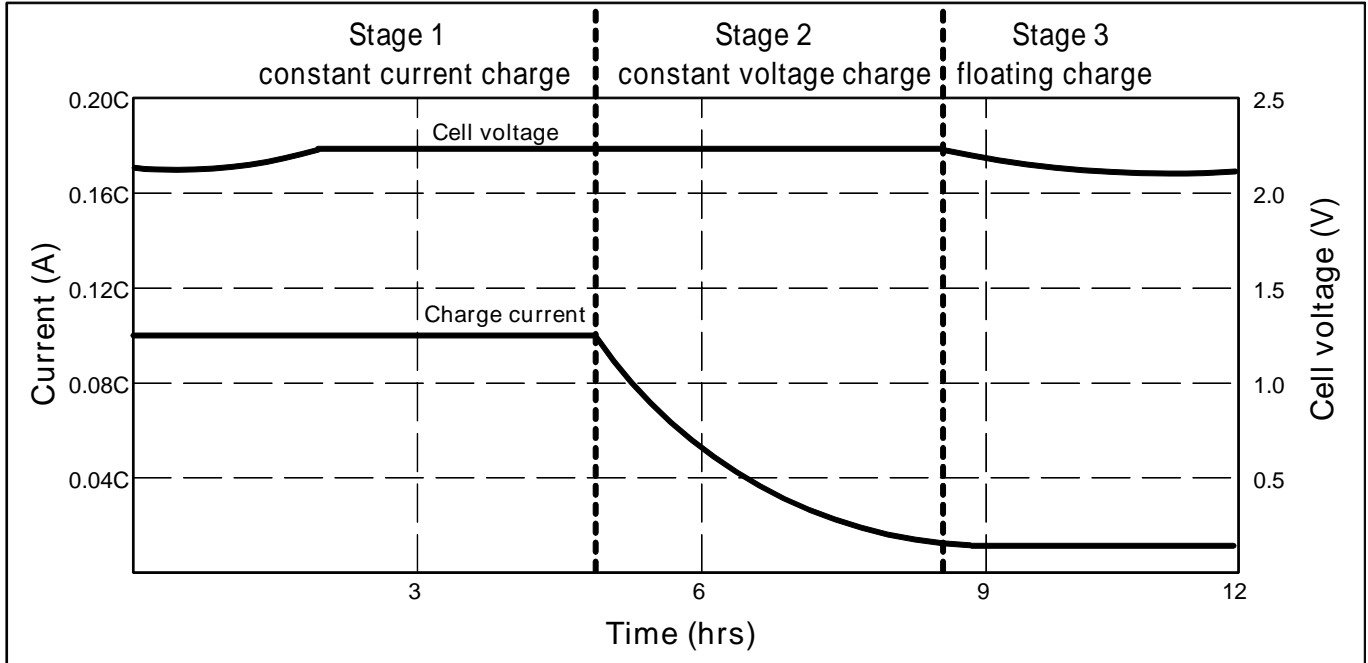

Figure 19 : Lead acid battery charging profile

This operating mode performs **lead-acid or lithium iron phosphate battery (LiFePO4)** battery charging. The device has not any cell balancing circuit therefore LiFePO4 packs/batteries must be provided with management boards. In Table 3 we have a summary of the battery capacity ranges based on its chemistry and devices model.

Two charging methods are possible: **normal charge** and **fast charge**.

Model	Max output current [A]	Nominal battery voltage [V]	Lead Acid		Lithium iron phosphate LiFePO4	
			Normal charge	Fast charge	Normal charge	Fast charge
			0.1 C	0.2 C	0.17C	0.33C
NPS2400-24	100	12 / 24	50...1000Ah	50...500Ah	50...600Ah	50...300Ah
NPS2400-48	50	48	25...500Ah	25...250Ah	25...300Ah	25...150Ah
NPS2400-72	33	60 / 72	15...300Ah	15...150Ah	15...180Ah	15...90Ah

Table 3 : Battery capacity ranges

With normal charge method, the charge current is limited to 0.1C (C/10) for lead acid or 0.17C (C/6) for LiFePO4 and this charging method takes approximately 12h to be completed. With fast charge method, the charge current is limited to 0.2C (C/5) for lead acid or 0.33C (C/3) for LiFePO4 and the charging time is approximately 8h. C is the current value in Ampere equal to the battery nominal capacity expressed in Ah (100Ah → 1C = 100A).

#### A lead acid cell charge chart is shown in

Figure 19, but the method for lithium iron phosphate batteries is the same only the cell voltage and charge current values are greater.

A charging algorithm, done in 3 stages, is implemented:

1. **Constant current charge:** during this phase the SMPS operates as a constant current source limited at 0.1C or 0.2C for lead acid batteries and at 0.17C or 0.33C for lithium iron phosphate (LiFePO4) batteries depending on normal or fast charge method. If the fast charge method is selected and the set battery capacity is higher than specified in Table 3, column “Fast charge”, the charge method is automatically switched to normal charge. The battery voltage progressively increases until it reaches the constant voltage charge value shown in Table 4, column “Constant voltage”. Stage 2 starts when this voltage is reached.

2. *Constant voltage charge*: during this phase the SMPS operates as a constant voltage source limited in current at 0.1C/0.2C or 0.17/0.33C (normal/fast charge) depending on battery technology previously described. The output voltage is kept constant at the value specified by column “Constant voltage” in Table 4. If the external temperature sensor is used the constant voltage charge voltage is varied based on the battery ambient temperature (3 mV/°C) for the lead acid battery. During this phase the current sunk by the battery starts to decrease. Stage 2 ends when the current sunk by the battery becomes lower than 0.03C or after 8 hrs of constant voltage charge. When Phase 2 is finished the DC-OK LED is ON and the relay is excited, indicating that the charging process is completed.

Nominal battery voltage [V]	Lead Acid		Lithium iron phosphate	
	Constant voltage [V]	Float voltage [V]	Constant voltage [V]	Float voltage [V]
12	14.4	13.5	14.6	13.85
24	28.8	27.0	29.2	27.75
48	57.6	54.0	58.4	55.50
60	72.0	67.5	73.0	69.35
72	86.4	81.0	87.6	83.20

**Table 4 : Charge method voltages**

3. *Floating charge*: during this phase the SMPS operates as a constant voltage source but the output voltage is decreased according to the value specified in Table 4, column “Float voltage”. If the external temperature sensor is used the floating charge voltage is varied based on the battery temperature for lead acid batteries. This phase is used to compensate the battery self-discharge current and to keep the battery at its maximum capacity. The charge ends after Phase 2, Phase 3 last until the battery is not disconnected.

#### 5.3.1.1 Revival function

Battery voltage is checked before starting a charge cycle. For batteries that were deep discharged, if their voltage is between the “Low battery voltage” and the “Start revival voltage” values in Table 5, the charger tries to revive the battery.

During revive the battery is charged with 0.04C. If after 10 hours the voltage on the battery still too low a battery error is triggered, otherwise a charging cycle is started (Stage 1).

To exit the error state the user must acknowledge the error using the OK button.

The revival function ends when the battery voltage reaches the “Stop revival voltage” in Table 5.

Nominal battery voltage [V]	Lead Acid			Lithium iron phosphate		
	Start revival voltage [V]	Low battery Voltage [V]	Stop revival voltage [V]	Start revival voltage [V]	Low battery voltage[V]	Stop revival voltage [V]
12	6	8.4	10.8	8	10	11.5
24	12	16.8	21.6	16	20	23
48	24	33.6	43.2	32	40	46
60	30	42	54	40	50	57.6
72	36	50.4	64.8	48	60	69.1

**Table 5 : Revival function voltages**

### 5.3.2 Nickel (NiCd, NiMH)

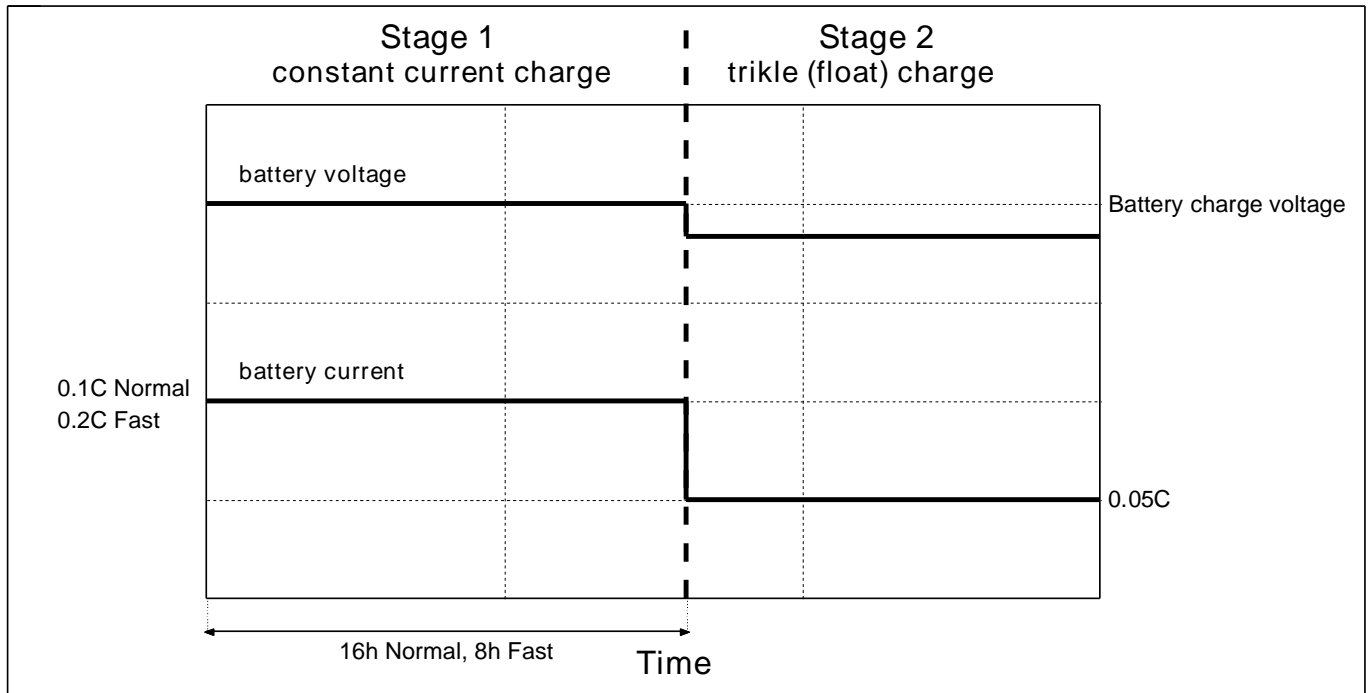

**Figure 20 : Nickel battery charging profile**

This operating mode performs **nickel** battery charging, both NiCd and NiMH batteries can be charged. The charging algorithm is shown in Figure 20, 2 stages are implemented:

- 1) *Constant current charge*: during this phase the SMPS operates as a constant current source limited at 0.1C or 0.2C with the maximum voltage limited to the “Battery charge voltage” (§6.4.16) set. Refer to Table 6, column “Battery voltage range” to have the complete battery voltage range. Stage 2 starts after 8h (fast charge) or 16h (normal charge) or if the battery is sinking a current lower than 0.025C.
- 2) *Trickle (float) charge*: the current is limited to 0.05C to avoid overcharge and compensate self-discharge of the battery. If the battery voltage fall under the 90% of the “Battery charge voltage” (§6.4.16) a pulsed charge is performed.

Table 6 shows the battery charging voltage and battery capacity ranges based on the device model.

Table 6 shows the battery charging voltage and battery capacity ranges based on the device model.

Model	Battery voltage range [V]	Battery capacity ranges	
		Normal charge	Fast charge
		0.1 C	0.2 C
NPS2400-24	12.8...29.0	50...1000Ah	50...500Ah
NPS2400-48	25.6...56.0	25...500Ah	25...250Ah
NPS2400-72	50.0...87.0	15...300Ah	15...150Ah

**Table 6 : Nickel battery voltage and capacity ranges**

## 6 User interface

### 6.1 Principles of operation

An integrated user interface composed of an LCD (alphanumeric, 2 x 16 characters, with backlight), 2 status LEDs and 4 buttons is present on the NPS2400. Through this interface the user can modify, monitor and control the SMPS behaviour. The physical layout of the interface is shown in Figure 21.

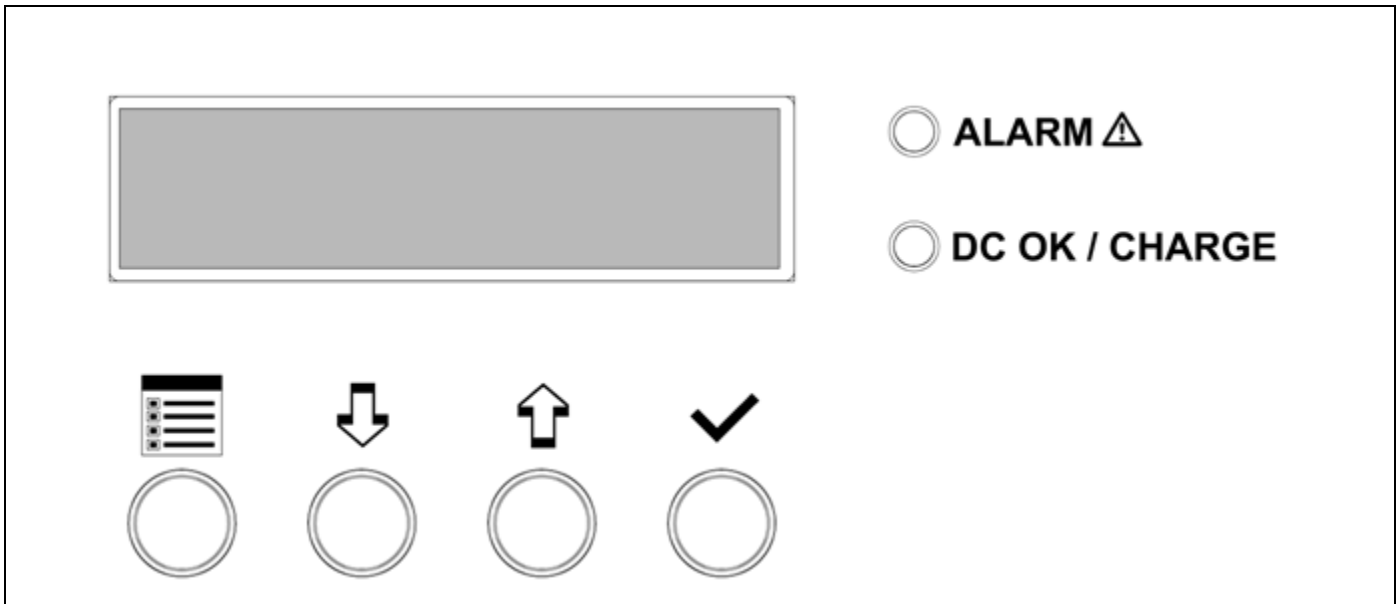







Figure 21 : User interface physical layout

	MENU KEY	Used to enter and exit various pages in the user menu.
	DOWN KEY	Scrolls down menus and values.
	UP KEY	Scrolls up menus and values.
	OK KEY	Confirms selection
RED LED	ALARM 	Shows an abnormal condition (either external or internal to the SMPS)
GREEN LED	DC OK / CHARGE	<ol style="list-style-type: none"> <li>1. in power supply modes: shows that the device is operating correctly and the output voltage is regulated</li> <li>2. in battery charger mode: blinks (1Hz) during charging and turns ON when the battery is charged</li> </ol>

## 6.2 Contrast adjustment

While in **DEFAULT SCREEN** keep the **OK KEY** pressed for at least 3 seconds and then use the **UP/DOWN KEYS** to adjust the desired LCD contrast.

## 6.3 Initial and standard screens

Initial and standard screens are shown in Figure 22:

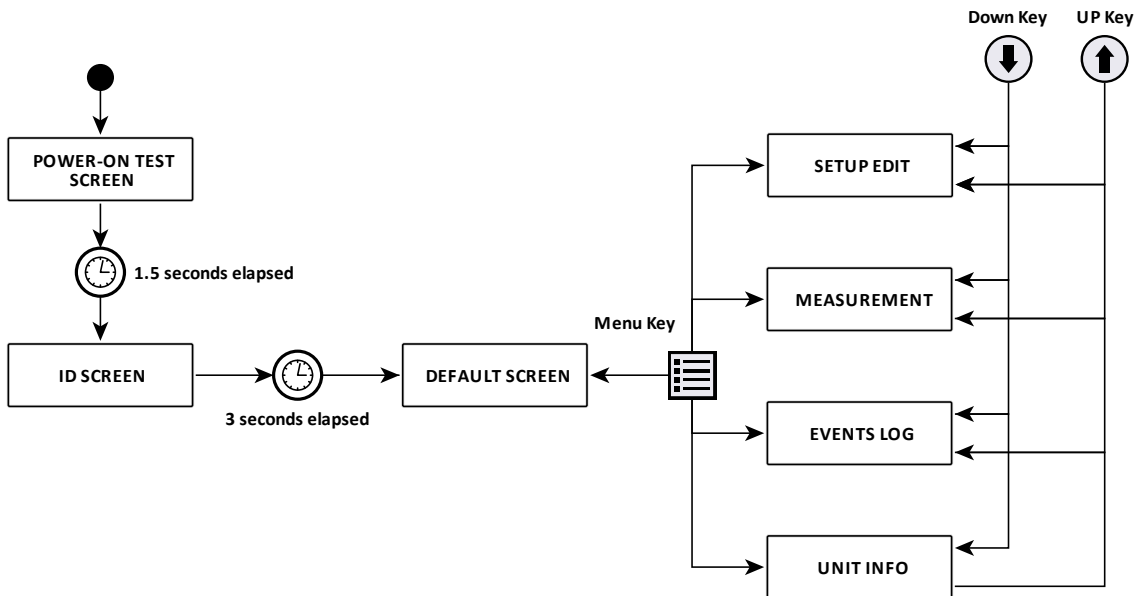

**Figure 22 : User interface layout**

When the SMPS is energized a *POWER ON TEST* is performed and a specific screen is displayed. This test checks the digital controller. Once the test is concluded an *ID SCREEN* is shown for 3 seconds. Consequently the *DEFAULT SCREEN* is shown. To activate the menu the user must press the **MENU KEY**, to exit the menu user can press on the **MENU KEY** again. Once the menu is enabled the user presses the **UP/DOWN KEYS** to scroll between submenus. The available menus are:

- |                         |   |
|-------------------------|---|
| 1) <b>SET-UP:</b>       | used to configure the SMPS by the user  |
| 2) <b>MEASUREMENTS:</b> | used to monitor SMPS voltages, currents and temperature                                 |
| 3) <b>EVENTS LOG:</b>   | accesses various logged events (alarms and errors). All are provided with a time stamp. |
| 4) <b>UNIT INFO:</b>    | displays specific information of the unit   |

If there is no activity in a submenu for >1 min, the *DEFAULT SCREEN* is displayed. Detailed description of the submenus is given below.

### 6.3.1 Power ON test screen

Action:

```
Self test
in progress...
```

### 6.3.2 ID screen

Device Name:

```
NPS2400X
```

Device Serial Number:

```
XXXXXXXXXXXXXXXXXXXX
```

### 6.3.3 Default screen

This is the screen that appears any time if there is no activity on the other menus for >1 minute. It shows the on going alarms (if present) or the on-line values of the main parameters of the unit.

Error or Alarm type:

```
OL Alarm
```

Offending value:

```
Iout=103A
```

Line 1 shows the error or alarm type, while line 2 shows the offending value causing it. When an alarm is present the **ALARM**  LED is ON and the buzzer is active (if enabled).

If no error or alarms are present and the mode is set to OVERBOOST or CURRENT-LIMIT the most significant measures are shown.

Uin, Pout:

```
Ui=xxxV Po=x.xkW
```

Uout, Iout:

```
Uo=xx.xV I=xxxA
```

If no error or alarms are present and the mode is set to BATTERY-CHARGER the charger status and other useful measures are shown:

Charger status, Temperature:

```
BC_CV xx.xC
```

Uout, Iout:

```
Uo=xx.xV I=xxxA
```

The available charger statuses are:

BC_CC	: Constant Current charge in process
BC_CV	: Constant Voltage charge in progress
BC_FLOAT	: Float Charge in progress
BC_OT	: Battery environment over-temperature condition (>50°C) – only if provided with optional Temp. sensor
BC_ERROR	: Battery is faulty or not connected
BC_REVIVE	: Charger is trying to revive the battery
BC_CHECK	: Battery is checked by the charger



## 6.4 Set-up menu

From this submenu it is possible to configure the SMPS. The layout of the submenu is shown in Figure 23.

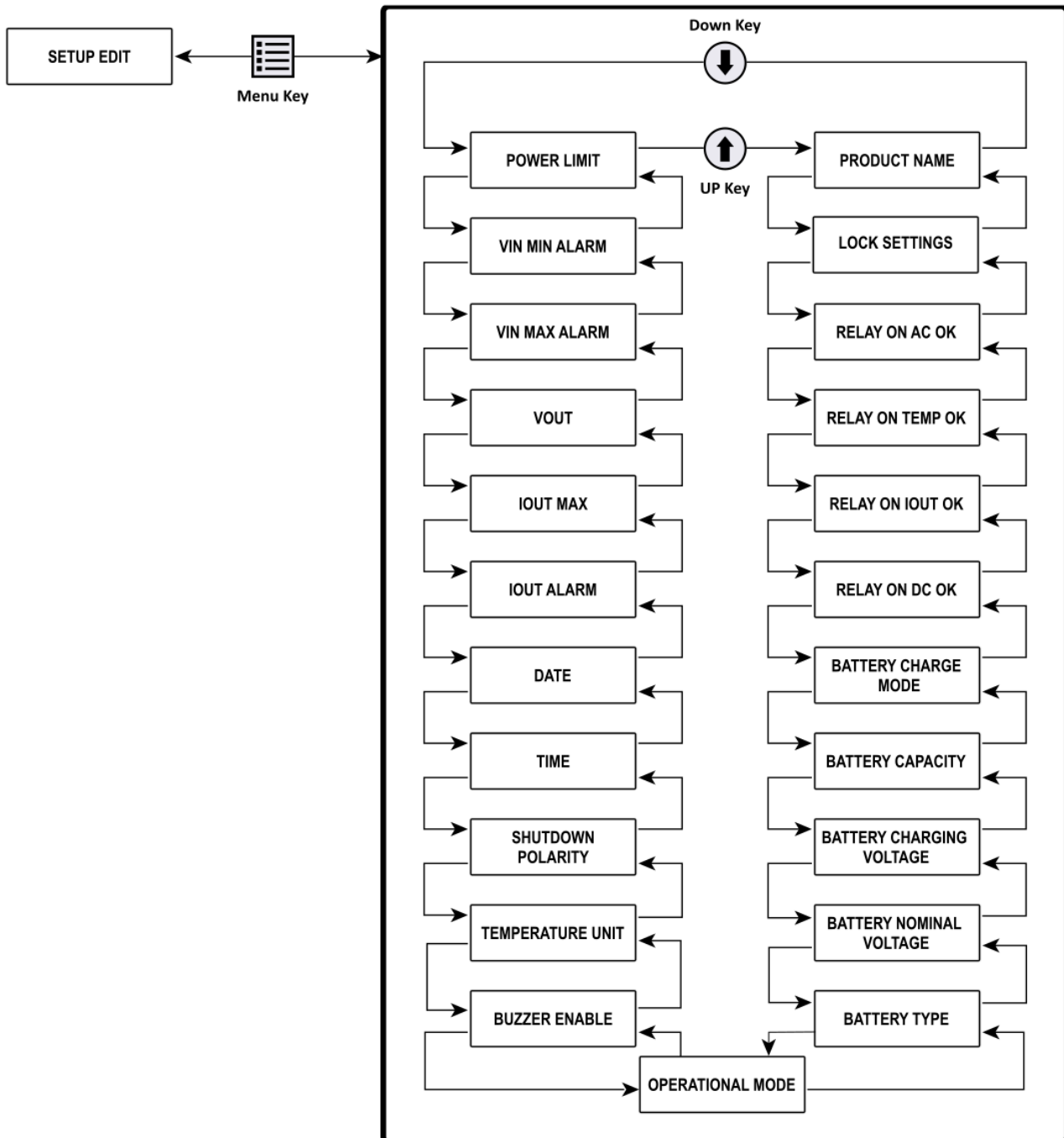

Figure 23 : Edit settings layout

By pressing the OK button user can start editing the selected parameter. Editing is done by scrolling the possible values with the UP/DOWN keys. If the KEYS are kept pressed they auto repeats at an accelerating frequency. To exit the edit mode press on the OK or MENU KEY.

#### 6.4.1 Power Limit

Setting:  
Value:

```
Power limit:  
2400W
```

In case of operation in high temperature environment is possible to reduce the maximum power of the device. Possible choices are 1500W/2000W/2400W.

Default: **2400W**

#### 6.4.2 Vin min alarm

Setting:  
Value:

```
Vin min alarm:  
340V
```

Use the UP/DOWN keys to select the *minimum input voltage* alarm threshold. Possible range is:  
 $340\text{ V} < \text{Vin min alarm} < \text{Vin max Alarm}$ .

Default: **340V**

#### 6.4.3 Vin max alarm

Setting:  
Value:

```
Vin min alarm:  
520V
```

Use the UP/DOWN keys to select the *maximum input voltage* alarm threshold. Possible range is:  
 $\text{Vin min alarm} < \text{Vin max alarm} < 580\text{V}$

Default: **570V**

#### 6.4.4 Vout

Setting:  
Value:

```
Vout:  
24.00V [Io=0.0A]
```

Use the UP/DOWN keys to set the *desired output voltage* **within the possible values for each model**. The range is model dependent and shown in Table 1. The actual output current is displayed in square brackets

Default: **24.00V / 48.00V / 72.00V / 170.0V** (model dependent)

#### 6.4.5 Nominal Iout

Setting:  
Value [actual output voltage]:

```
Iout nom:  
100A [Vo=24.00V]
```

Use the UP/DOWN keys to set the desired *nominal output current*. In case of OVERBOOST mode 150% of this value is supplied for a maximum of 5 consecutive seconds. When the current exceeds this value an overload condition is triggered. The actual output voltage is displayed in square brackets.

Default: **100A / 50A / 33A / 14A** (model dependent)

#### 6.4.6 Iout alarm threshold

Setting:  
Value:

```
Iout alarm:  
100A
```

Use the UP/DOWN keys to select the desired *output current* alarm threshold.  
*Default: 100A / 50A / 33A / 14A* (model dependent)

#### 6.4.7 Date

Setting:  
Value:

```
Date:  
Tue 04/01/2011
```

Use the UP/DOWN keys to modify the *date*. Press OK or MENU key to advance the *cursor* to the next editable field, once the editable fields are finished press one more time to save and return to previous menu.

#### 6.4.8 Time

Setting:  
Value:

```
Time:  
11:19:38
```

Use the UP/DOWN keys to modify the *time*. Press OK or MENU key to advance the cursor to the next editable field, once the editable fields are finished press one more time to save and return to previous menu.

#### 6.4.9 Remote shutdown polarity

Setting:  
Value:

```
Remote ShutDown:  
HIGH
```

Use the UP/DOWN keys to modify the remote shut down polarity (LOW or HIGH).  
*Default: HIGH*

#### 6.4.10 Temperature measurement unit

Setting:  
Value:

```
Temp. unit:  
CELSIUS
```

Use the UP/DOWN keys to modify the *temperature measurement* unit (CELSIUS or FAHRENHEIT).  
*Default: CELSIUS*

#### 6.4.11 Enable buzzer

Setting:  
Value:

```
Enable buzzer:  
DISABLED
```

Use the UP/DOWN keys to enable/disable the *buzzer* in case of an alarm. During an alarm the buzzer can also be muted by pressing the OK button while in DEFAULT SCREEN for more than 3 seconds.  
*Default: DISABLED*

#### 6.4.12 Wiring

Setting:  
Value:

```
Wiring:  
3-PHASE
```

Use the UP/DOWN key to select the desired input wiring between 3-PHASE and 2-PHASE. In 2-PHASE the maximum output power is limited to 1200W.

*Default: 3-PHASE*

#### 6.4.13 Operating mode

Setting:  
Value:

```
Operating mode:  
OVERBOOST
```

Use the UP/DOWN key to select the desired operating mode between OVERBOOST / CURRENT LIMIT / BATTERY CHARGER (battery charger only available on the “-24”, “-48” and “-72” models).

*Default: OVERBOOST*

#### 6.4.14 Battery type

Setting:  
Value:

```
Bat. type:  
LEAD ACID
```

This submenu is present only if operating mode is set to BATTERY CHARGER. Use the UP/DOWN key to select the nominal battery type. Possible choices are “LEAD ACID”, “NICKEL” and “LITHIUM LiFePO4”.

*Default: Lead acid*

#### 6.4.15 Battery nominal voltage (only for lead acid or LiFePO4 on “-24”, “-48” and “-72” models)

Setting:  
Value:

```
Bat. nom. volt.:  
12V
```

This submenu is present only if operating mode is set to BATTERY CHARGER. Use the UP/DOWN key to select the nominal battery voltage of lead acid/LiFePO4 batteries. Possible choices are 12V or 24V for “-24” model, 48V for “-48” model and 60V or 72V for “-72” model.

*Default: 12V / 48V (model dependent)*

#### 6.4.16 Battery charge voltage (only for nickel on “-24”, “-48” and “-72” models)

Setting:  
Value:

```
Bat. ch. volt.:  
12.8V
```

This submenu is present only if operating mode is set to BATTERY CHARGER. Use the UP/DOWN key to select the battery charge voltage for NiCd/NiMH batteries. Range is 12.8V to 29V for “-24” model, 25.6V to 56V for “-48” model and 50V to 87V for “-72” model.

*Default: 12.8V / 25.6V / 50V (model dependent)*

#### 6.4.17 Battery capacity (only on “-24”, “-48” and “-72” models)

Setting:  
Value:

```
Bat. capacity:  
50Ah
```

This submenu is present only if operating mode is set to BATTERY CHARGER. Use the UP/DOWN keys to select the nominal battery capacity. Range is 50Ah up to 600/1000Ah for “-24” model, 25Ah up to 300/500Ah for “-48” model and 15Ah to 300Ah for “-72” model. Refer to Table 3 for the maximum battery capacity based on chemistry. The lead acid and nickel batteries share the same maximum capacities.

*Default: 50Ah / 25Ah / 15Ah (model dependent)*

#### 6.4.18 Battery charge mode (only on “-24”, “-48” and “-72” models)

Setting:  
Value:

```
Bat. ch. mode:  
NORMAL
```

This submenu is present only if operating mode is set to BATTERY CHARGER. Use the UP/DOWN keys to select the desired battery charging mode between NORMAL (0.1C lead acid / 0.17C LiFePO4) or FAST (0.2C lead acid / 0.33C LiFePO4).  
*Default: NORMAL*

#### 6.4.19 Relay active on “DC OK”

Setting:  
Value:

```
Relay DC OK:  
ENABLED
```

Use the UP/DOWN key to enable/disable *the relay on “DC OK”*, the relay is excited when  $V_{out} > 0.9 \cdot V_{out\_set}$ . In BATTERY-CHARGER mode this relay function is disabled.  
*Default: ENABLED*

#### 6.4.20 Relay active on “Iout OK”

Setting:  
Value:

```
Relay Iout OK:  
DISABLED
```

Use the UP/DOWN keys to enable/disable *the relay on “Iout OK”*, the relay is excited when  $I_{out} < I_{out\_alarm}$ . In BATTERY-CHARGER mode this relay function is disabled.  
*Default: DISABLED*

#### 6.4.21 Relay active on “Temperature OK”

Setting:  
Value:

```
Relay Temp OK:  
DISABLED
```

Use the UP/DOWN key to enable/disable *the relay on “Temperature OK”*, the relay is excited when the internal transformer **temperature is < 110°C (230°F)**. In BATTERY-CHARGER mode this relay function is disabled.  
*Default: DISABLED*

#### 6.4.22 Relay active on “AC OK”

Setting:  
Value:

```
Relay AC OK:  
DISABLED
```

Use the UP/DOWN key to enable/disable the relay on “AC input OK” (means the AC voltage is within the user defined window), the relay is excited when the  $V_{in\_min\_alarm} < V_{in} < V_{in\_max\_alarm}$ . In BATTERY-CHARGER mode this relay function is disabled.  
*Default: DISABLED*

#### 6.4.23 Lock settings

Setting:  
Value:

```
Lock settings:  
DISABLED
```

Used to lock the settings editing in order to avoid unintentional changes. Use UP/DOWN key to enable/disable the function. When enabled any attempt to change parameters will show a “Settings locked” message followed by the current parameter

value. Keeping pressed at the same time for at least 3 seconds the up and down button while on "Edit settings" menu toggles the Lock settings value.

*Default:* **DISABLED**

#### 6.4.24 Product name

Setting:

Value:



Product name:  
NPS2400

Use UP/DOWN key to change character and OK key to increment to the next string character.

*Default:* **NPS2400**

## 6.5 Measurements

The UP/DOWN keys are used to scroll between pages. MENU key is used to return to the previous menu. The screen is refreshed every 500 ms. **The average values are calculated from the beginning of the operation of the unit.**

### 6.5.1 Page 1

Input voltage, output power:  
Output voltage, output current:

```
Ui=xxxV Po=x.xkW
Uo=xx.xV I=xxxA
```

### 6.5.2 Page 2

Average output power:  
Average output current:

```
Pow.[av.]=xxxxW
Iout.[av.]=xxx.xA
```

### 6.5.3 Page 3

Actual internal temperature:  
Average internal temperature:

```
Temp[ac.]=xx.xC
Temp[av.]=xx.xC
```

### 6.5.4 Page 4

Charger status, Battery Ambient Temp.:  
Uout, Iout:

```
BC_FLOAT xx.xC
Uo=xx.xxV I=xxxA
```

### 6.5.5 Measurement accuracy

Measure	24V model	48V model	72V model	170V model
Input voltage	±5% ±5VAC			
Output voltage	±1% ±0.3V	±1% ±0.6V	±1% ±0.9V	±1% ±1.8V
Output current	±2% ±2A	±3% ±2A	±3% ±2A	±4% ±2A
Remote output current:	±5% ±2A			
Internal temperature	± 4°C			
External temperature	± 4°C			

**Table 7 : Measurements accuracy**

## 6.6 Event log

There are 3 categories of information saved by NPS2400 units (logged for further monitoring purposes) in a non-volatile memory. The maximum number of stored events is 408. When the storage capacity is reached the oldest event is overwritten.

- 1) **ERRORS:** these are **critical** events (either external or internal to SMPS) that impede the correct operation of the unit, leading to its shutdown. They are listed in Table 8.

ID	Code	Name	Condition
0	OL	Over Load	Iout > Inom for more then 5 seconds (hiccup)
1	OT	Over Temperature	Transformer Temperature > 125°C (257°F)
2	OOV	Output Over Voltage	Vout > Max Vout Nominal
3	IUV	Input Under Voltage	Vin < 330V
4	IOV	Input Over Voltage	Vin > 530V
5	PUV	PFC Under Voltage	Vpfc < 300V
6	POV	PFC Over Voltage	Vpfc > 450V
7	PSF	Phase Shift Failure	While power converted is ON Vout = 0V & Iout = 0V
8	SC	Short Circuit	While in Constant Current Mode Vout = 0V

**Table 8 : Errors**

- 2) **ALARMS:** these are events (either external or internal to SMPS) that are out of nominal values, but do not impede the operation of the unit. They are listed in Table 9.

ID	Code	Name	Condition
20	OLS	Over Load Start	Iout > IoutAlarm (§6.4.6)
21	OLE	Over Load End	Overload condition ends
22	OTS	Over Temperature Start	Transformer Temperature > 115°C (239°F)
23	OTE	Over Temperature End	Over Temperature condition ends
24	IUVS	Input Under Voltage Start	Vin < VinMinAlarm (§6.4.2)
25	IUVE	Input Under Voltage End	Input Under Voltage condition ends
26	IOVS	Input Over Voltage Start	Vin > VinMaxAlarm (§6.4.3)
27	IOVE	Input Over Voltage End	Input Over Voltage condition ends
28	Ph Loss St.	Phase Loss Start	SMPS working on two phases only
29	Ph Loss End	Phase Loss End	Phase Loss condition ends

**Table 9 : Alarms**

- 3) **EVENTS:** These are standard operations (e.g. unit POWER ON or SHUT DOWN) which are logged just for reference of operating conditions. They are listed in Table 10.

ID	Code	Name	Condition
40	Rem. ShDown	Remote Shutdown	Remote Shutdown activated
41	Power ON	Power ON	SMPS powered ON
50	BC CC	Battery Charger Constant Current	Battery starts Constant Current phase
51	BC CV	Battery Charger Constant Voltage	Battery start Constant Voltage phase
52	BC Float	Battery Charger Float	Battery charged, float charge phase
53	BC Error	Battery Charger Error	Battery Error, i.e. Vbat too low
54	BC OT	Battery Charger Over Temperature	Battery ambient temperature < 50°C
55	BC Revive	Battery Charger Reviving	Battery charger is trying to revive the battery

**Table 10 : Events**

The UP/DOWN keys are used to scroll between events. The log report is exportable to a PC see using interface box COMM BOX.



### 6.6.1 Over Load error

Code, Type, Offending value:  
Time stamp:

```
OL (ER) 142A  
ddmmyy hh:mm:ss
```

*Event:* In OVERBOOST mode, **lout > lout\_nom** for more then 5 seconds. The device enters a hiccup cycle.

### 6.6.2 Over Temperature error

Code, Type, Offending value:  
Time stamp:

```
OT (ER) 125C  
ddmmyy hh:mm:ss
```

*Event:* **transformer temperature > 125°C (257°F)**. The device trips to thermal shutdown.

### 6.6.3 Output Overvoltage error

Code, Type, Offending value:  
Time stamp:

```
OOV (ER) 32.0V  
ddmmyy hh:mm:ss
```

*Event:* **Unit internal error**. The output voltage can be no more regulated and it trips to its maximum value. When such error occurs the device goes in a latched shutdown mode. A mains power cycle is needed to recover from such error.

### 6.6.4 Input Under Voltage error

Code, Type, Offending value:  
Time stamp:

```
IUV (ER) 325V  
ddmmyy hh:mm:ss
```

*Event:* **Vin < 330VAC**. The SMPS remains switched off until Vin > 340VAC

### 6.6.5 Input Over Voltage error

Code, Type, Offending value:  
Time stamp:

```
IOV (ER) 545V  
ddmmyy hh:mm:ss
```

*Event:* **Vin > 530VAC**. The SMPS remains switched off until Vin is decreased below 520VAC

### 6.6.6 PFC Under Voltage error

Code, Type, Offending value:  
Time stamp:

```
PUV (ER) 295V  
ddmmyy hh:mm:ss
```

*Event:* **VPFC < 300V**. The internal PFC bus voltage can be no more regulated. When such error occurs the device goes in a latched shutdown mode. A mains power cycle is needed to attempt a recover from such error. Most of the cases this is an unrecoverable error and the device needs to be serviced.

### 6.6.7 PFC Over Voltage error

Code, Type, Offending value:  
Time stamp:

```
POV (ER) 455V  
ddmmyy hh:mm:ss
```

*Event:* **VPFC > 450V**. The internal PFC bus voltage can be no more regulated. When such error occurs the device goes in a latched shutdown mode. A mains power cycle is needed to attempt a recover from such error. Most of the cases this is an unrecoverable error and the device needs to be serviced.

### 6.6.8 DC/DC Converter Failure error

Code, Type:  
Time stamp:

```
PSF (ER)
ddmmyy hh:mm:ss
```

*Event:* **Vout = 0V and Iout = 0A.** The internal DC/DC converter is not working properly. When such error occurs the device goes in a latched shutdown mode. A mains power cycle is needed to recover from such error. Most of the cases this is an unrecoverable error and the device needs to be serviced.

### 6.6.9 Short Circuit error

Code, Type:  
Time stamp:

```
SC (ER)
ddmmyy hh:mm:ss
```

*Event:* While in CONSTANT CURRENT mode the voltage drops below 1V for more then 0.5 seconds. The device enters a hiccup cycle.

### 6.6.10 Over Load alarm start

Code, Type, Offending value:  
Time stamp:

```
OLS (AL) 100A
ddmmyy hh:mm:ss
```

*Event:* **Iout > IoutAlarm** (§6.4.6)

### 6.6.11 Over Load alarm end

Code, Type, Maximum value:  
Time stamp:

```
OLE (AL) 130A
ddmmyy hh:mm:ss
```

*Event:* Over Load condition alarm ends. Maximum value is the highest Iout measured during the alarm.

### 6.6.12 Over Temperature alarm start

Code, Type, Offending value:  
Time stamp:

```
OTS (AL) 115C
ddmmyy hh:mm:ss
```

*Event:* **Transformer temperature > 115 °C (239 °F)**

### 6.6.13 Over Temperature alarm end

Code, Type, Maximum value:  
Time stamp:

```
OTE (AL) 115C
ddmmyy hh:mm:ss
```

*Event:* Over Temperature alarm condition ends. Maximum value is the highest temperature measured during the alarm.

### 6.6.14 Vin Under Voltage alarm start

Code, Type, Offending value:  
Time stamp:

```
IUVS(AL) 330V
ddmmyy hh:mm:ss
```

*Event:* **Vin < VinMinAlarm** (§6.4.2).

#### 6.6.15 Vin Under Voltage alarm end

Code, Type, Minimum value:  
Time stamp:

```
IOVE(AL) 310V
ddmmyy hh:mm:ss
```

*Event:* Vin Under Voltage alarm condition ends. Minimum value is the lowest Vin measured during the alarm

#### 6.6.16 Vin Over Voltage alarm start

Code, Type, Offending value:  
Time stamp:

```
IOVS(AL) 545V
ddmmyy hh:mm:ss
```

*Event:* Vin > VinMaxAlarm

#### 6.6.17 Vin Over Voltage alarm end

Code, Type, Maximum value:  
Time stamp:

```
IOVE(AL) 547V
ddmmyy hh:mm:ss
```

*Event:* Vin Over Voltage alarm condition ends. Maximum value is the highest Vin measured during the alarm

#### 6.6.18 Phase Loss alarm start

Code, Type:  
Time stamp:

```
Ph Loss St. (AL)
ddmmyy hh:mm:ss
```

*Event:* A mains **phase is missing for > 10s**. In case of a phase loss alarm the maximum output power is reduced an half.

#### 6.6.19 Phase Loss alarm end

Code, Type:  
Time stamp:

```
Ph Loss End (AL)
ddmmyy hh:mm:ss
```

*Event:* Phase Loss alarm condition ends.

#### 6.6.20 Maintenance Due alarm start

Code, Type:  
Time stamp:

```
Maint. Due (AL)
ddmmyy hh:mm:ss
```

*Event:* Maintenance is due.

#### 6.6.21 Maintenance Due alarm end

Code, Type:  
Time stamp:

```
Maint. OK (AL)
ddmmyy hh:mm:ss
```

*Event:* Maintenance done

#### 6.6.22 Remote Shutdown event start

Code, Type:  
Time stamp:

```
Rem.Sh. St. (EU)
ddmmyy hh:mm:ss
```

*Event:* The device has been **remotely shut down** through the remote shutdown input.

### 6.6.23 Remote Shutdown event end

Code, Type:  
Time stamp:

```
Rem.Sh. End (EU)
ddmmyy hh:mm:ss
```

*Event:* The device exits **remote shut down** through the remote shutdown input.

### 6.6.24 Power On event

Code, Type:  
Time stamp:

```
Power ON (EU)
ddmmyy hh:mm:ss
```

*Event:* The unit has been **energized**.

### 6.6.25 Battery Charger Constant Current event.

Code, Type:  
Time stamp:

```
BC CC (EU)
ddmmyy hh:mm:ss
```

*Event:* In BC mode the **unit started the constant current phase** (see §5.3).

### 6.6.26 Battery Charger Constant Voltage event

Code, Type:  
Time stamp:

```
BC CV (EU)
ddmmyy hh:mm:ss
```

*Event:* In BC mode the **unit started the constant voltage phase** (see §5.3).

### 6.6.27 Battery Charger Float event

Code, Type:  
Time stamp:

```
BC Float (EU)
ddmmyy hh:mm:ss
```

*Event:* In BC mode the **unit started the constant voltage phase** (see §5.3).

### 6.6.28 Battery Charger Error event

Code, Type:  
Time stamp:

```
BC ERROR (EU)
ddmmyy hh:mm:ss
```

*Event:* In BC mode the **unit started the constant voltage phase** (see §5.3).

### 6.6.29 Battery Charger Over Temperature event

Code, Type:  
Time stamp:

```
BC OT (EU)
ddmmyy hh:mm:ss
```

*Event:* In BC mode the **unit started the constant voltage phase** (see §5.3).

## 6.7 Information

Factory set generic information (ID, etc.) is available under this menu. The UP/DOWN keys are used to scroll between the pages.

### 6.7.1 Model

Item:  
Model code:

```
Model:  
NPS2400-24
```

### 6.7.2 Serial Number

Item:  
Serial number:

```
Serial Number:  
1234567890
```

### 6.7.3 Firmware

Item:  
Firmware version:

```
Firmware:  
V00.00
```

### 6.7.4 Date

Item:  
Date:

```
Date[dd/mm/yy]  
TUE 04/01/2011
```

### 6.7.5 Time

Item:  
Time:

```
Time [hh:mm:ss]:  
14:09:27
```

### 6.7.6 Mains event counter

Item:  
Total count:

```
Mains events:  
xxxxxx
```

This counter is incremented every time a mains related event happens. *Mains related events* are: **Input Under Voltage**, **Input Over Voltage** and **Phase Loss**.

### 6.7.7 Load event counter

Item:  
Total count:

```
Load events:  
xxxxxx
```

This counter is incremented every time a load related event happens. Load related events are: **Over Load** and **Short Circuit**.

### 6.7.8 Environmental event counter

Item:  
Total count:

```
Env. events:  
xxxxxx
```

The counter is incremented every time an environment related event happens. Environmental events are: **SMPS Over Temperature** and **Battery Ambient Over Temperature**.

Minimum mounting clearances are shown on Figure 24.

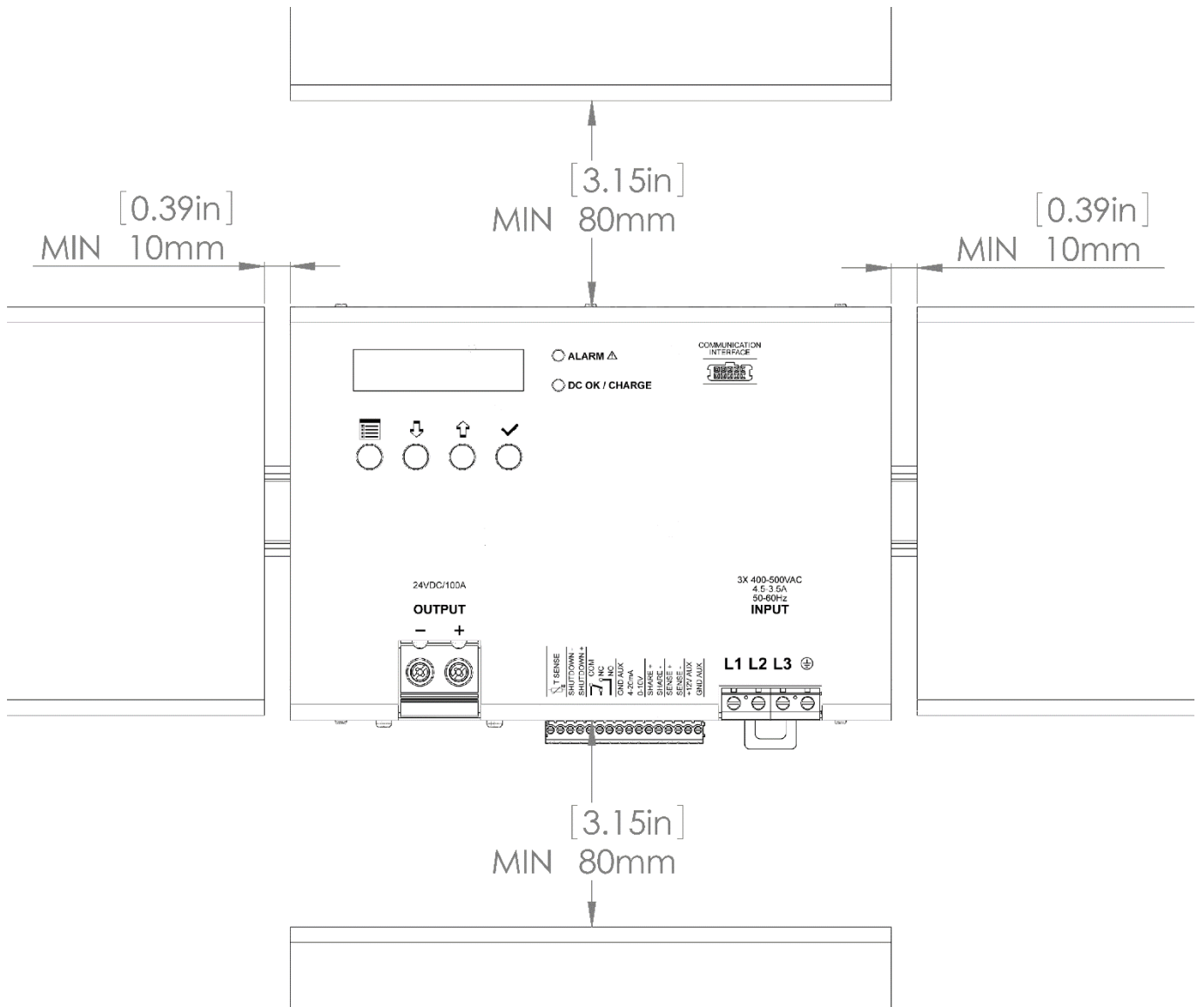

**Figure 24 : Minimum mounting clearance**

SMPS dimensions are shown on Figure 25.

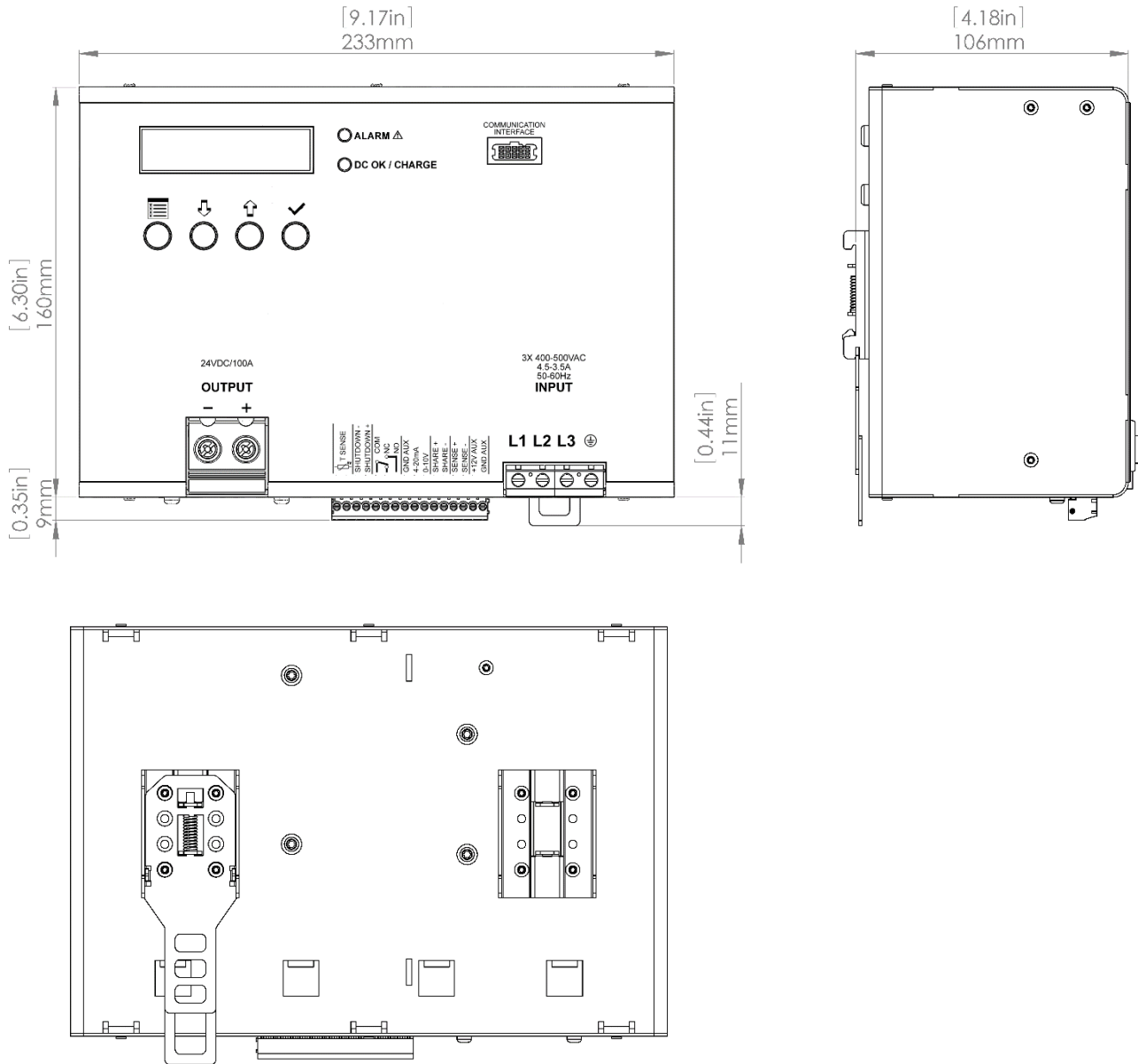

**Figure 25 : Dimensions**